

说明书归档首页

说明书编号:	M00124Q			版本号:	V01		
编制说明 (首版编制时请填写)	<input checked="" type="checkbox"/> 全新编制	适用产品序列:	新型Switch Box				
		适用机型系列:	HCHM-N04X/N08X/N12X/N16X				
	<input type="checkbox"/> 衍生机型	衍生产品序列:					
		衍生机型系列:					
		源产品序列:					
		源机型系列:					
	<input type="checkbox"/> 临时对应	源说明书编号:		版本号:			
		对应简要说明:					
		源说明书编号:		版本号:			
	签字区		签名			日期	
	设计:	刘峻杉			2017. 12. 25		
	审核:	曹培春			2017. 12. 26		
标准化:	陶友淘			2017. 12. 26			
批准	赵连池			2018. 01. 16			
变更履历 (变更说明书时请填写)	标记	管理编号:	日期:	更改:	审核:	批准:	
	△×	BZ/KF-1901-171	2019. 1. 29	薛杰			
本次变更内容简述	变更内容简要描述				涉及页码		
	CHANGE-OVER BOX 改为Switch Box				全册		
	Switch-BOX 改为Switch Box				全册		
	H-LINK信息去除				全册		
	MULTI-KIT改为BRANCH PIPE				全册		
	接管图和接线图信息优化, 补充水模块功能				P14、P23		
备注 (必填)	担当联络方式	80879469	邮箱	liujunshan@hisensehitachi.com			
	说明书封面材质	100g双胶纸	说明书内页材质	70g双胶纸			
	说明书图幅	A4	是否彩色印刷	否			

Installation Manual

*for
Cooling / Heating
Switch Box*

Models:

**HCHM-N04X
HCHM-N08X
HCHM-N12X
HCHM-N16X**

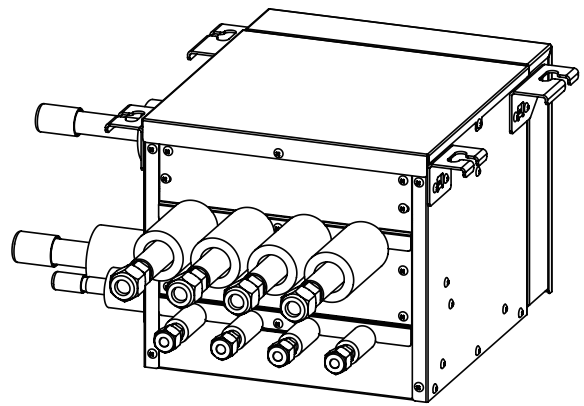

IMPORTANT:

*READ AND UNDERSTAND
THIS MANUAL
CAREFULLY
BEFORE INSTALLING
THIS SWITCH BOX. KEEP
THIS MANUAL FOR
FUTURE REFERENCE.*



1097069

M00124Q

ORIGINAL INSTRUCTIONS

IMPORTANT NOTICE

- The applicable outdoor unit may be different depending on the product series. Improper combination causes the unit to malfunction and an alarm will be triggered. Be sure to confirm with the product catalogue before installation.
- Hisense/HITACHI pursues a policy of continuous improvement in the design and performance of products to meet regulatory requirements and industry standards. Therefore, Hisense/HITACHI reserves the right to revise specifications without notice.
- Hisense/HITACHI cannot anticipate every possible circumstance that might involve a potential hazard.
- This heat pump air conditioner is designed for standard air conditioning applications only. Do not use this heat pump air conditioner for other purposes, such as drying clothes, refrigerating foods, or for any other cooling or heating process.
- Do not install the unit outdoors. Do not install the unit in the following places. It may cause a fire deformation, corrosion or failure.
 - * Places where there are high levels of oil mist (including machinery oil).
 - * Places where there are high alkalinity levels (i.e., chlorine or bromine such as over hot tubs, etc.).
 - * Places where flammable gases or liquids may be used or generated.
 - * Places with a high concentration of salts, salty mists or sprays (such as over salt-water aquariums).
 - * Places with an atmosphere of high nuisance dust. Places with organic solvent atmospheres, such as painting and cleaning locations.
- Do not install a unit in the place where condensate water can leak onto the unit or electrical device failures may occur.
- Pay attention to the following points when the unit is installed in a hospital or other facility where electromagnetic waves generate from medical equipment.
 - * Do not install the unit in places where electromagnetic waves radiate to the electrical box, wired controller cable or wired controller.
 - * Install the unit at least 3m (10 ft) away from electromagnetic waves or interferences such as a radio.
- The installer and system specialist shall secure against leakage according to local regulations or standards. This system has both high and low pressure refrigerant and, as such, comprises a pressurized system. Never loosen threaded joints while the system is under pressure and never open pressurized system parts.
- No part of this manual may be reproduced without written permission from Hisense/HITACHI.
- It is assumed that this heat pump air conditioner will be operated and serviced by English speaking people. If this is not the case, the distributor or dealer can provide or add safety, caution and operating signs in the native language.
- If you have any questions, contact your distributor.
- This manual describes the features of this heat pump air conditioner as well as for other models.

This manual should be considered as a permanent part of the air conditioning equipment and should remain with the air conditioning equipment.

CHECKING PRODUCT RECEIVED

- Upon receiving this product, inspect it for any shipping damage. Inspect all electrical connections. Connections must be clean and tight at the terminals. Claims for damage either apparent or concealed, should be filed immediately with the shipping company.
NOTE: Rough handling may dislocate internal components.
- Check the model number, electrical characteristics (power supply, voltage and frequency) and accessories to determine if they are correct with the ordering and shipping information, to ensure the correct unit has been shipped.
To minimize the possibility of damage after inspection, the units should be installed and reassembled as soon as possible.

The standard installation and general use of this unit is explained in this manual. Although common processes and procedures for installing units are presented in this manual, its use for installation of units otherwise indicated in this manual is not recommended. Please contact your local agent, as the occasion arises. Our liability shall not cover defects arising from the alteration performed by a customer without our consent in a written form.

SAFETY SUMMARY

Signal Words

- Signal words are used to identify levels of hazard seriousness. Definitions for identifying hazard levels are provided below with their respective signal words.

 : DANGER indicates a hazardous situation which, if not avoided, will result in death or serious injury.

 : WARNING indicates a hazardous situation which, if not avoided, could result in death or serious injury.

 : CAUTION used with the safety alert symbol, indicates a hazardous situation which, if not avoided, could result in minor or moderate injury.

 : NOTICE is used to address practices not related to personal injury.

NOTE : NOTE is useful information for operation or maintenance.

SAFETY SUMMARY

⚠ DANGER

- Do not perform installation work, refrigerant piping work, condensate pump, or condensate piping and electrical wiring connection without referring to the installation manual. If the instructions are not followed, it may result in a water leakage, electric shock or a fire
- Use the specified non-flammable refrigerant (R410A) for the outdoor unit in the refrigerant cycle. Charge only R410A into the unit. Do not charge other materials into the unit such as hydrocarbon refrigerants (propane), oxygen, flammable gases (acetylene) or poisonous gases when installing, maintaining and moving the unit. These flammables are extremely dangerous and may cause an explosion, a fire, or injury. As originally manufactured, this unit contains refrigerant installed by Hisense/HITACHI. Hisense/HITACHI uses only refrigerants that have been approved for use in the unit's intended country or market. Hisense/HITACHI's distributors similarly are only authorized to provide refrigerants that have been approved for use in the countries or markets they serve. The refrigerant used in this unit is identified on the unit's faceplate and/or in the associated manuals. Any additions of refrigerant into this unit must comply with the country's requirements with regard to refrigerant use and should be obtained from Hisense/HITACHI distributors. Use of unapproved refrigerant substitutes will void the warranties and can cause injury or death.
- Do not pour water into the indoor or outdoor unit. These units are equipped with electrical parts. Exposure to water may cause a serious electrical shock.
- Do not open the service cover or access panel for the indoor or outdoor units without turning OFF the main power supply.
- Do not touch or adjust safety devices inside the indoor unit or outdoor units. If these devices are touched or readjusted, it may cause a serious accident.
- Carefully check for escaping refrigerant gas. If there is significant leakage, it can cause difficulty in breathing. Turn OFF the main switch, and contact your service contractor if refrigerant leakage occurs.
- Make sure that the refrigerant leakage test is performed.
Refrigerant (fluorocarbon for this unit is incombustible, non-toxic and odorless.
However if the refrigerant is leaked and comes in contact with fire toxic gas will generate.
Because fluorocarbon is heavier than air, the floor surface will be filled with it, which could cause suffocation.
- The installer and system specialist shall secure against refrigerant leakage according to local regulations or standards.
- Use a Earth Leakage Breaker (ELB).
In the event of fault, there is danger of an electric shock or a fire if it is not used.

SAFETY SUMMARY

WARNING

- Do not use any sprays such as insecticide, lacquer, hair spray or other flammable gases within approximately 1.3m (4 ft) from the system.
- If the circuit breaker or fuse is often activated, stop the system and contact your service contractor.
- Check that the ground wiring is securely connected. If the unit is not correctly grounded, it may cause electric shock. Do not connect the ground wiring to gas piping, condensate piping, lighting conductor or ground wiring for telephones.
- Before performing any brazing work, check to ensure that there is no flammable material around. When using refrigerant, be sure to wear leather gloves to prevent injury from cold.
- Insulate electrical wiring, condensate piping, and electrical components from threats posed by burrowing animals and temperature extremes. Failure to do so can, over time, deteriorate system performance.
- Secure the cables. External forces on the terminals could lead to a fire.
- Tighten the flare nut with a torque wrench in the specified manner. Do not apply excessive force to the flare nut when tightening. If you do, the flare nut can crack and refrigerant leakage may occur.
- When maintaining, relocating or disposing of the unit, dismantle the refrigerant piping after the compressor stops.
- Highly dangerous electrical voltages are used in this system. Carefully refer to the wiring diagram and these instructions when wiring. Improper connections and inadequate grounding can cause serious injury or death.
- Perform all electrical work in strict accordance with this installation and maintenance manual and all relevant regulatory standards.
- Use specified cables between units.
- Be sure to install circuit breakers (ground fault interrupter, isolating switch, molded case circuit breaker and so on), with the specified capacity. Ensure that the wiring terminals are tightened securely to recommended torque specifications. If a circuit breaker or fuse is frequently activated, shut down the system and contact your service contractor.
- Clamp electrical wires securely with a cable clamp after all wiring is connected to the terminal block. In addition, run wires securely through the wiring access channel.
- When installing the power lines, do not apply tension to the cables. Secure the suspended cables at regular intervals, but not too tightly.
- After stopping operation, be sure to wait at least five minutes before turning off the main power switch. Otherwise, water leakage or electrical breakdown may result. Disconnect the power supply completely before attempting any maintenance for electrical parts. Check to ensure that no residual voltage is present after disconnecting the power supply.
- Insulate the refrigerant pipe connection to prevent condensation.
- Be sure to attach the cover so that it fits securely on the electrical box without any gaps. Secure the cover with screws.

⚠ CAUTION

- Do not step on the unit.
- Do not put any foreign material on the unit or inside the unit.
- Provide a strong and correct foundation so that:
 - The outdoor unit is not on an incline.
 - Abnormal sound does not occur.
 - The outdoor unit will not fall down due to a strong wind or earthquake.

NOTICE

- Be careful that moisture, dust, or variant refrigerant compounds not enter the refrigerant system during installation work. Foreign matter could damage internal components or cause blockages.
- Do not install the indoor unit, outdoor unit, wired controller and cable within approximately 3m (10 ft) of strong electromagnetic wave radiators such as medical equipment.
- After a long shutdown, apply power to the outdoor unit(s) at least 12 hours prior to operation of the system for preheating of the compressor oil.

NOTE

- It is recommended that the room is ventilated every three to four hours.
- The heating capacity of the heat pump unit is decreased according to the outdoor air temperature. Therefore, it is recommended that auxiliary heating equipment be used in the field when the unit is installed in a low temperature region.

IMPORTANT NOTICE

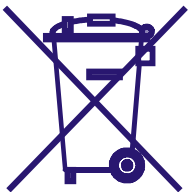

Correct Disposal of this product

This marking indicates that this product should not be disposed with other household wastes. To prevent possible harm to the environment or human health from uncontrolled waste disposal, recycle it responsibly to promote the sustainable reuse of material resources. To return your used device, please use the return and collection systems or contact the retailer where the product was purchased. They can take this product for environmental safe recycling.

TABLE OF CONTENTS

1. Safety Summary	1
2. Structure	1
2.1 Dimensions.....	1
2.2 Refrigeration Cycle.....	4
2.3 Necessary Tools and Instrument List for Installation	5
3. Transportation and Handling.....	6
3.1 Transportation	6
3.2 Handling of Switch Box.....	6
3.3 Combination of Switch Box and Indoor Unit	6
4. Switch Box Installation	7
4.1 Factory-Supplied Accessories	7
4.2 Initial Check.....	8
4.3 Suspension Bolts.....	9
4.4 Installation	10
4.4.1 Marking of the Positions of the Suspension Bolts and Wiring Connections	10
4.4.2 Mounting and Hanging the Switch Box.....	10
5. Refrigerant Piping Work.....	11
5.1 Refrigerant Piping.....	11
5.2 Refrigerant Piping Work	13
6. Electrical Wiring	21
6.1 General Check	21
6.2 Electrical Wiring Connection	22
6.3 Electrical Wiring.....	24
6.4 Setting of DIP Switches.....	25
7. Test Run.....	26
8. Safety and Control Device Setting	27

1. Safety Summary

⚠ WARNING

- Do not perform installation work, refrigerant piping work or electrical wiring connection without referring to our installation manual.
- Check that the ground wire is securely connected.
- Connect a fuse of specified capacity.

⚠ CAUTION

Do not install the Switch Box and cable within approximately 3m (10 ft) from strong electromagnetic wave radiators such as medical equipment.

2. Structure

2.1 Dimensions

HCHM-N04X

Unit: mm

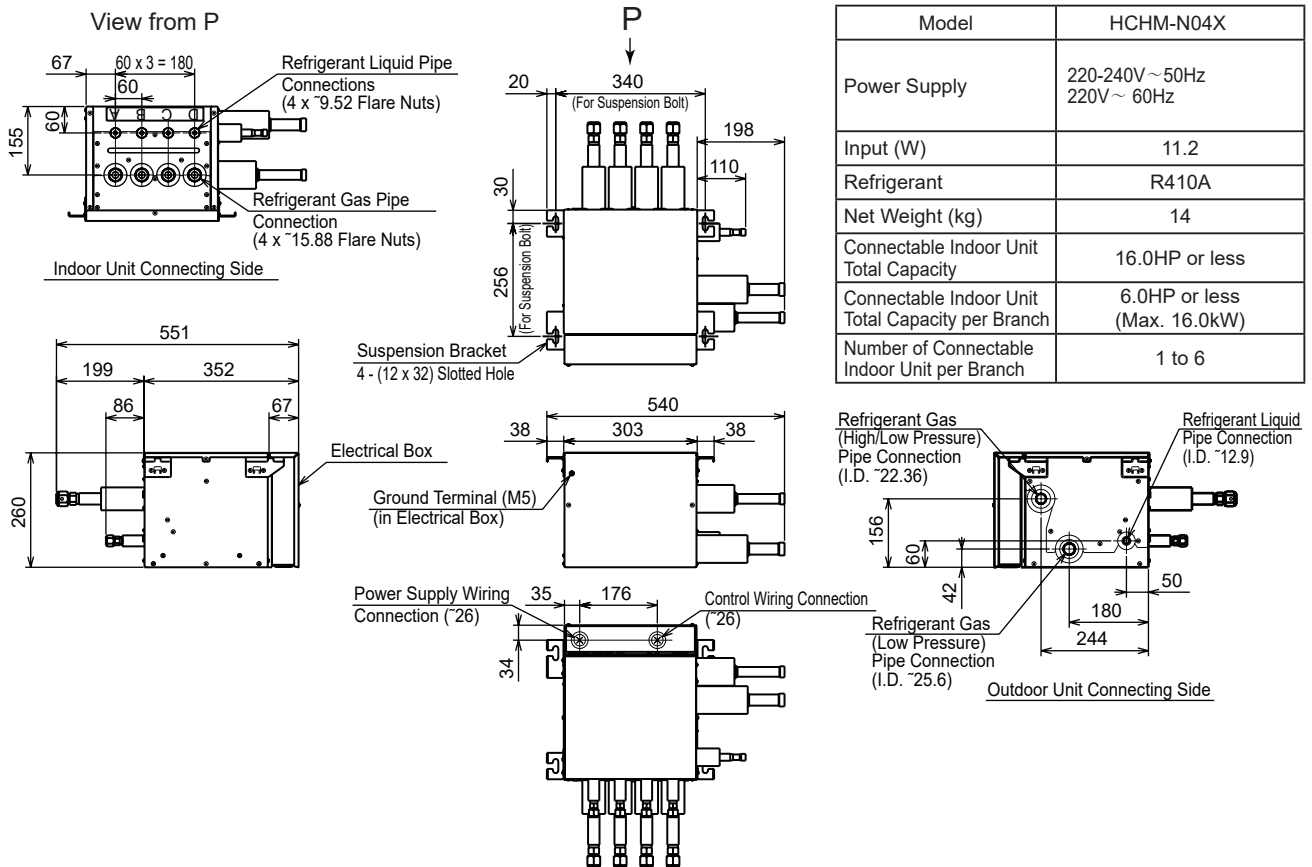
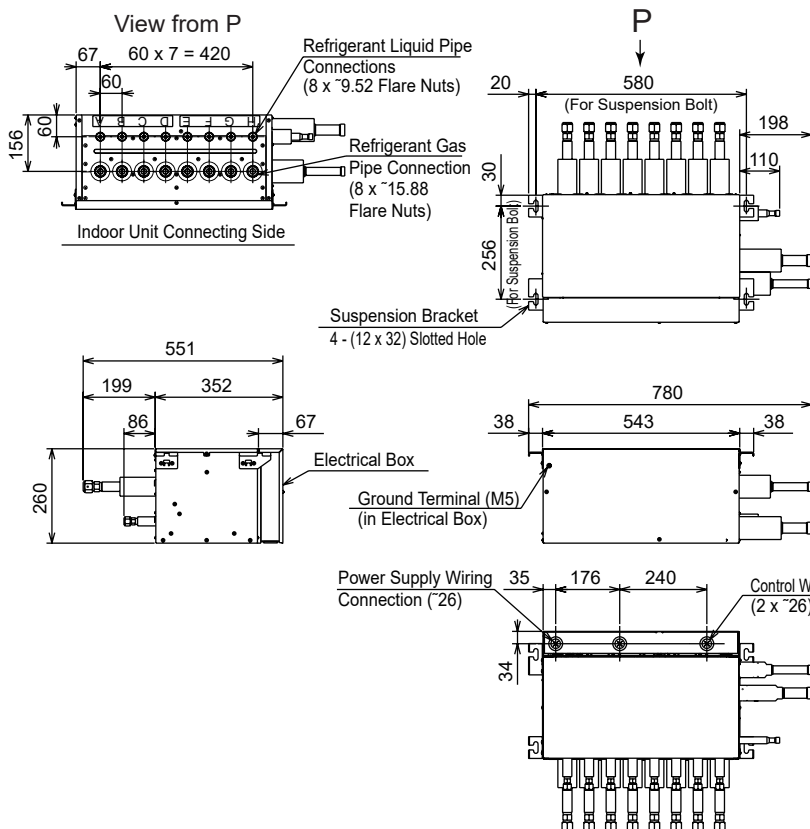

Figure 2.1 Dimensions of Switch Box

HCHM-N08X

Specification



Model	HCHM-N08X
Power Supply	220-240V ~ 50Hz 220V ~ 60Hz
Input (W)	22.4
Refrigerant	R410A
Net Weight (kg)	25
Connectable Indoor Unit Total Capacity	30.0HP or less
Connectable Indoor Unit Total Capacity per Branch	6.0HP or less (Max. 16.0kW)
Number of Connectable Indoor Unit per Branch	1 to 6

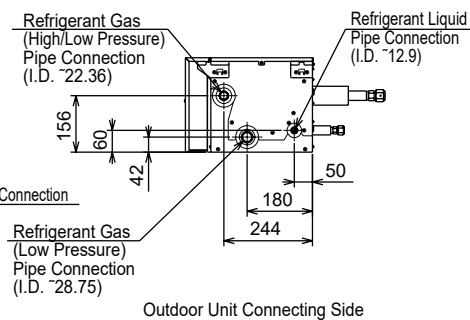

HCHM-N12X

Specification

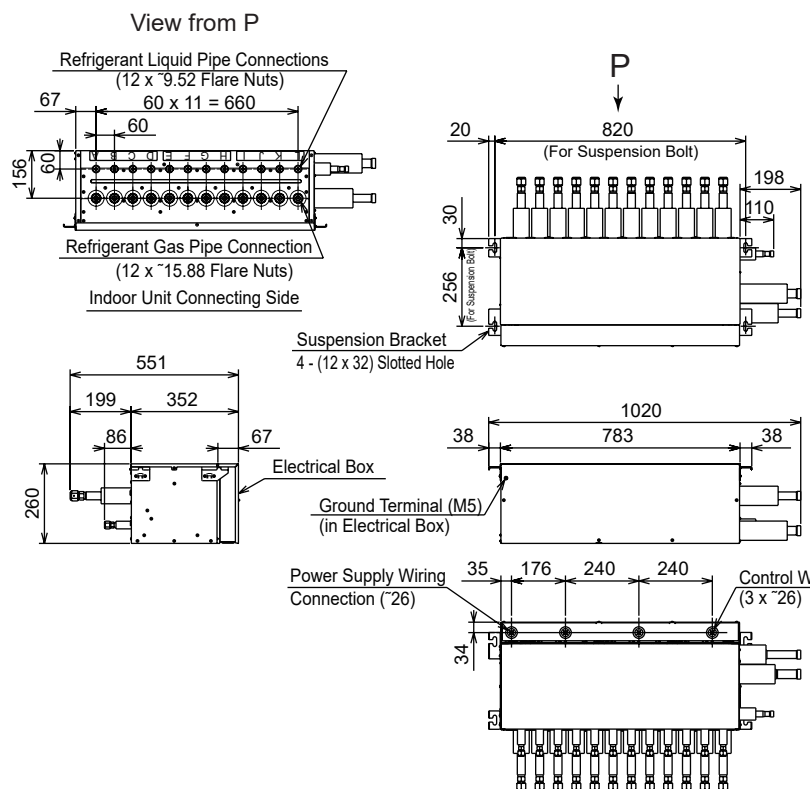

Model	HCHM-N12X
Power Supply	220-240V ~ 50Hz 220V ~ 60Hz
Input (W)	33.6
Refrigerant	R410A
Net Weight (kg)	36
Connectable Indoor Unit Total Capacity	30.0HP or less
Connectable Indoor Unit Total Capacity per Branch	6.0HP or less (Max. 16.0kW)
Number of Connectable Indoor Unit per Branch	1 to 6

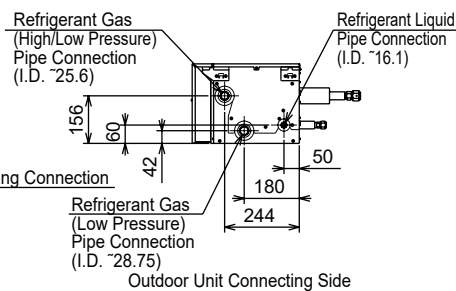

Figure 2.2 Dimensions of Switch Box

Specification

Model	HCHM-N16X
Power Supply	220-240V ~ 50Hz 220V ~ 60Hz
Input (W)	44.8
Refrigerant	R410A
Net Weight (kg)	47
Connectable Indoor Unit Total Capacity	30.0HP or less
Connectable Indoor Unit Total Capacity per Branch	6.0HP or less (Max. 16.0kW)
Number of Connectable Indoor Unit per Branch	1 to 6

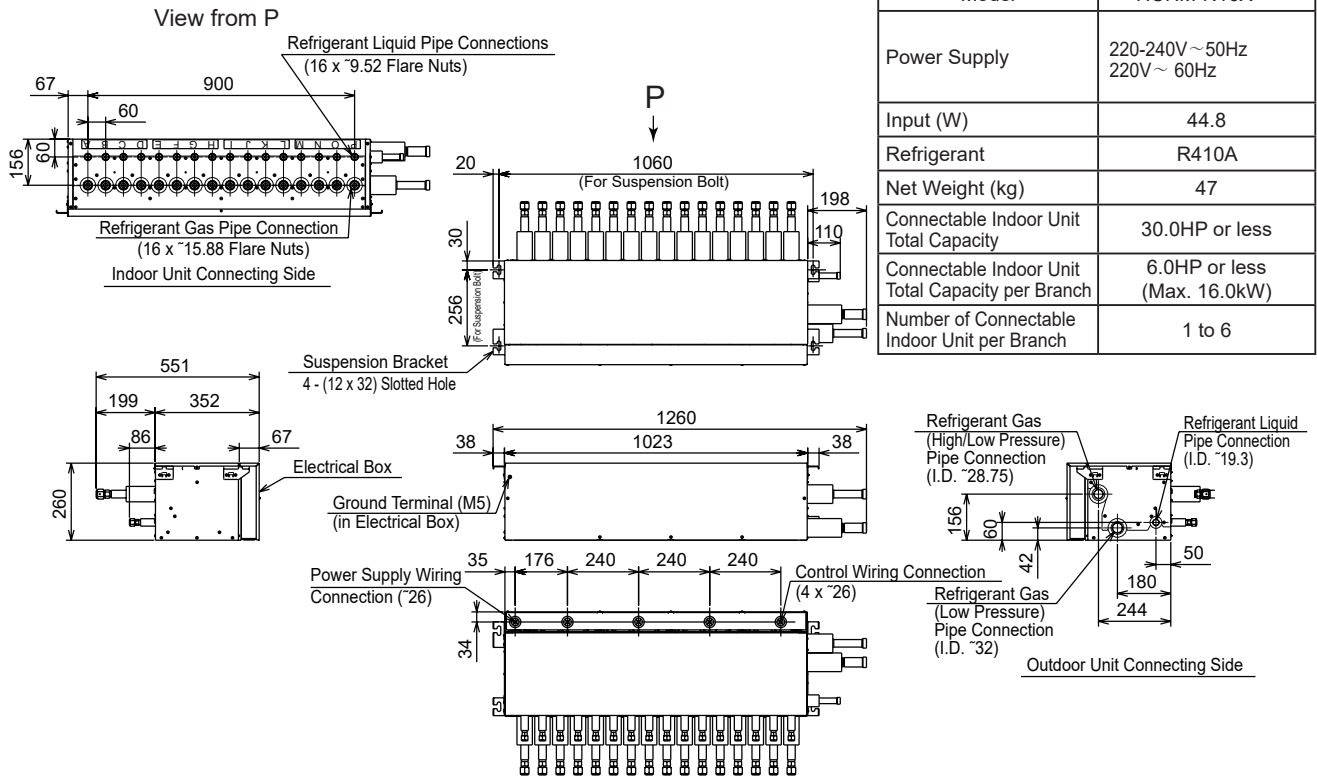

Figure 2.3 Dimensions of Switch Box

2.2 Refrigeration Cycle

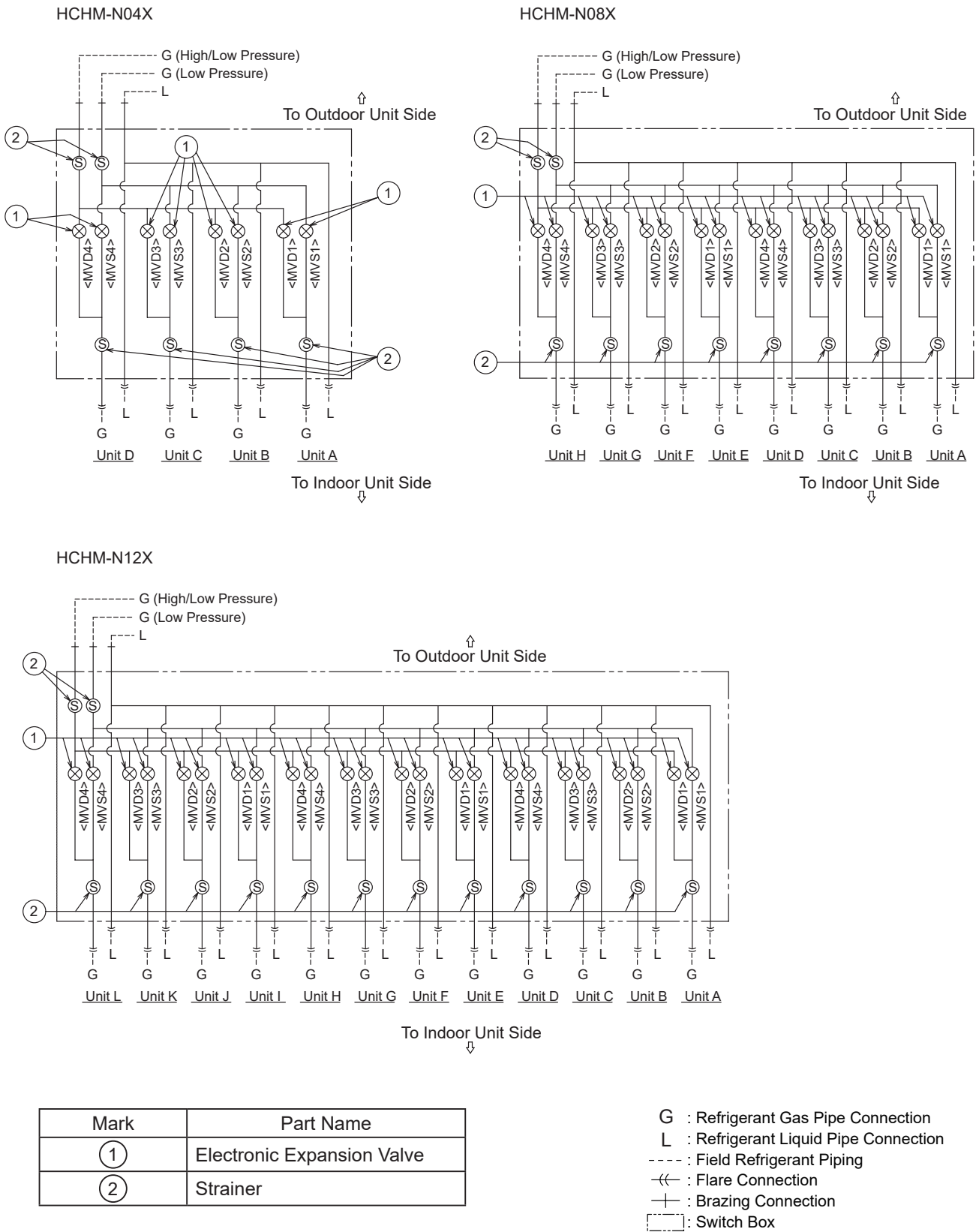
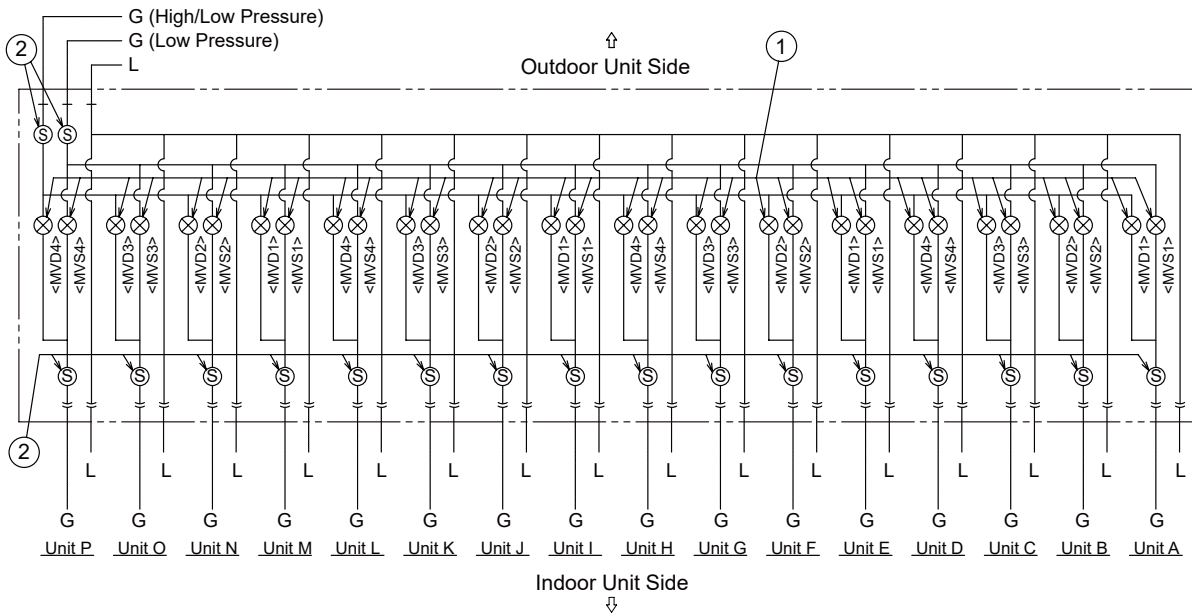

Figure 2.4 Refrigeration Cycle Diagram

HCHM-N16X



Mark	Part Name
①	Electronic Expansion Valve
②	Strainer

- G : Refrigerant Gas Pipe Connection
- L : Refrigerant Liquid Pipe Connection
- : Field Refrigerant Piping
- ⇐⇐ : Flare Connection
- ⊕ : Brazing Connection
- ⋯ : Switch Box

Figure 2.5 Refrigeration Cycle Diagram

2.3 Necessary Tools and Instrument List for Installation

No.	Tool	No.	Tool
1	Handsaw	11	Wrench
2	Phillips Screwdriver	12	Charging Cylinder
3	Vacuum Pump	13	Manifold Gauge
4	Refrigerant Gas Hose	14	Wire Cutter
5	Megohmmeter	15	Gas Leak Detector
6	Copper Pipe Bender	16	Level
7	Manual Water Pump	17	Crimper for Solderless Terminals
8	Pipe Cutter	18	Hoist (for Indoor Unit)
9	Brazing Kit	19	Ammeter
10	Hex Wrench	20	Voltage Meter

NOTE:

Use tools and measuring instruments (vacuum pump, refrigerant hose, charging cylinder, and manifold gauge) exclusively for the refrigerant R410A.

3. Transportation and Handling

3.1 Transportation

Transport the product as close to the installation location as practicable before unpacking.



Do not put any material on the product.

3.2 Handling of Switch Box



Do not put any foreign material into the indoor unit and check to ensure that none exists in the Switch Box before the installation and test run. Otherwise, a fire or failure, or something similar may occur.



Be careful not to damage insulation materials of unit's surface when lifting.

3.3 Combination of Switch Box and Indoor

Unit Combination is as follows.

Table 3.1 Combination of Indoor Unit

Model		HCHM-N04X	HCHM-N08X	HCHM-N12X	HCHM-N16X
Number of Branches (for Indoor Unit)		4	8	12	16
Single Unit Per Branch	Maximum Total Capacity of All Connected Indoor Units	16.0HP or less (Max. 44.8kW)	30.0HP or less (Max. 85.0kW)	30.0HP or less (Max. 85.0kW)	30.0HP or less (Max. 85.0kW)
	Maximum Total Capacity of Connected Indoor Units Per Branch	6.0HP or less (Max. 16.0kW)	6.0HP or less (Max. 16.0kW)	6.0HP or less (Max. 16.0kW)	6.0HP or less (Max. 16.0kW)
Multiple Units Per Branch	Maximum Number of Connected Indoor Units Per Branch	6	6	6	6
	Maximum Total Capacity of All Connected Indoor Units	16.0HP or less (Max. 44.8kW)	30.0HP or less (Max. 85.0kW)	30.0HP or less (Max. 85.0kW)	30.0HP or less (Max. 85.0kW)
	Maximum Total Capacity of Connected Indoor Units Per Branch	6.0HP or less (Max. 16.0kW)	6.0HP or less (Max. 16.0kW)	6.0HP or less (Max. 16.0kW)	6.0HP or less (Max. 16.0kW)

NOTES:

- Exceeding the total capacity may cause insufficient performance and abnormal sound. Be sure to connect the Switch Box within the allowable total capacity.
- In case of 8HP or 10HP type indoor unit connection:
 Only single unit per branch is allowed to be connected.
 Up to two 8HP or 10HP type indoor units can be connected to the Switch Box within the "Maximum Total Capacity of All Connected Indoor Units" shown in above table.
 Make sure to increase the pipe connection size by using the appropriate accessory pipe.

4. Switch Box Installation

⚠ DANGER

- Do not install the Switch Box in a flammable environment to avoid fire or an explosion.

⚠ WARNING

- Check to ensure that the ceiling slab is strong enough.
- Do not install the Switch Box outdoors. If installed outdoors, an electric hazard or electric leakage may occur.
- Installation **WARNING**: Ensure that all safety features, disconnects and interlocks are in place and functioning properly prior to putting the equipment into operation. Never by-pass or jump-out any safety device or switch.

4.1 Factory-Supplied Accessories

















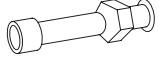
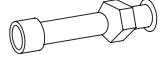
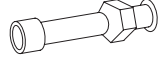
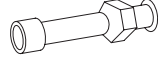

Check to ensure that the following accessories are packed with the Switch Box.

NOTE

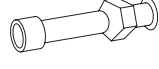
If any of these accessories are not packed with the unit, please contact your distributor.

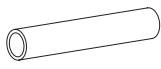
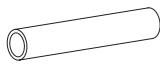
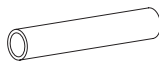
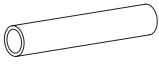
Table 4.1 Factory-Supplied Accessories

Unit: mm (inch)

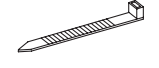
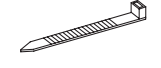
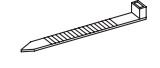
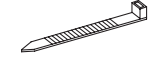
No.	Accessory	HCHM-N04X	Q'ty	HCHM-N08X	Q'ty	HCHM-N12X	Q'ty	HCHM-N16X	Q'ty	
(1)	Accessory Pipe	$\phi 15.88$ (5/8) → ID $\phi 12.9$ (1/2)		4		8		12		16
(2)		$\phi 9.52$ (3/8) → ID $\phi 6.5$ (1/4)		4		8		12		16
(3)		$\phi 15.88$ (5/8) → ID $\phi 19.3$ (3/4)		2		2		2		2
(4)		$\phi 15.88$ (5/8) → ID $\phi 22.2$ (7/8)		1		2		2		2
(5)	Insulation Material	ID 26 (ID 1)		4		8		12		16
(6)		ID 35 (ID 1-3/8)		4		8		12		16
(7)	Clamp		17		34		51		68	

4.2 Initial Check

- Install the Switch Box with a proper clearance around it for maintenance working space, as shown in Figure 4.1 below.

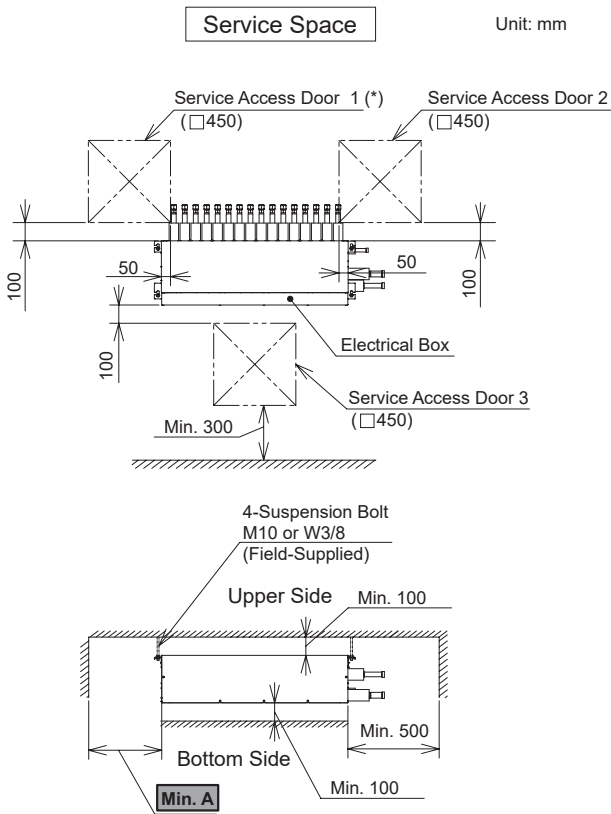

* Service access door 1 is required for models HCHM-N04X, HCHM-N08X, HCHM-N12X and HCHM-N16X.

Model \ Size	A
HCHM-N04X	Min. 100
HCHM-N08X	Min. 400
HCHM-N12X	
HCHM-N16X	

Purpose of Each Service Access Door

Name	Purpose
Service Access Door 1	Use during inspection of indoor unit connecting side.
Service Access Door 2	Use during inspection of indoor unit connecting side.
Service Access Door 3	Use during inspection of electrical components inside electrical box.

Figure 4.1 Service Space

- Check to ensure that the ceiling is sufficiently strong to sustain the Switch Box. If the ceiling is weak, abnormal sound and vibration may occur.
- When the electronic expansion valve in the Switch Box is activated, a change in the typical refrigerant flow sounds may be heard or perceived from the Switch Box. Take the following action to minimize the sound.
 - (A) Install the Switch Box inside the ceiling. As for the ceiling material, select a material like a plasterboard at least 9mm (1 inch), which minimizes operation sound.
 - (B) Do not install the Switch Box in a place near bedrooms or hospital rooms.
- When the operation is changed to cooling/heating mode, a change in the typical refrigerant flow sounds may be heard or perceived from the Switch Box. Therefore, install the Switch Box in the ceiling of the corridor so that the refrigerant flowing sound may not be heard in the room.
- Do not install the Switch Box in a hot or humid place, such as a kitchen, to prevent condensation on the outer surface of the Switch Box. When installing the Switch Box in such places, apply additional insulation.
- Pay attention to the following points when the Switch Box is installed in a hospital or other facility where there are electronic waves from medical equipment.
 - (A) Do not install the Switch Box where the electromagnetic wave is directly radiated to the electrical box or communication cable.
 - (B) Install the Switch Box and components as far as practicable or at least 3m (10 ft) from the electromagnetic wave radiator.
 - (C) Install a noise filter when the power supply emits harmful noises.
- Ensure the installation place is convenient for the refrigerant piping or electrical wiring connection.
- Do not drill, or drive screws into the cabinet. Use only mounting points provided.
- In case the Switch Box is required to move from the ceiling, prepare another service access door.

4.3 Suspension Bolts

Step 1

- (1) Select a final location and installation direction of the Switch Box.
Pay careful attention to the space for the piping, wiring and maintenance.
- (2) Mount suspension bolts.
- (3) Contact a qualified contractor or carpenter for the ceiling treatment.

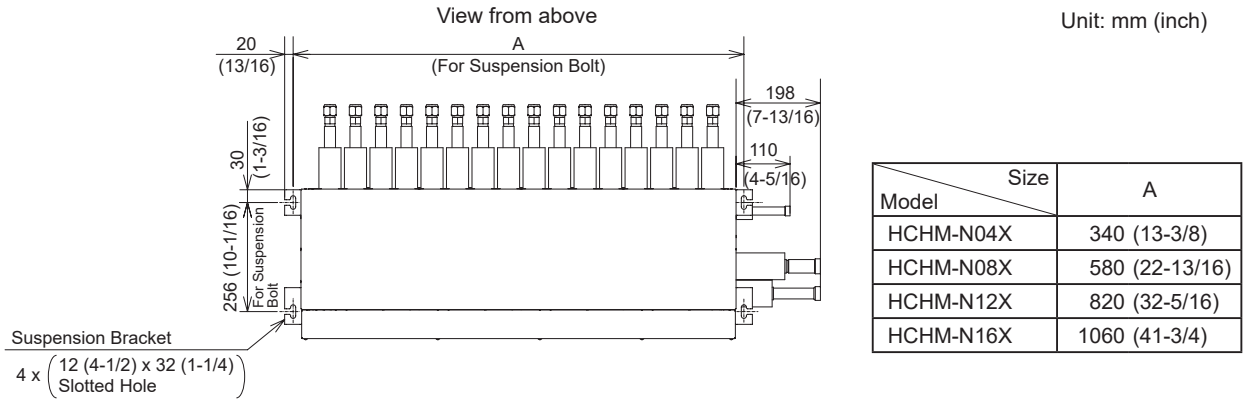
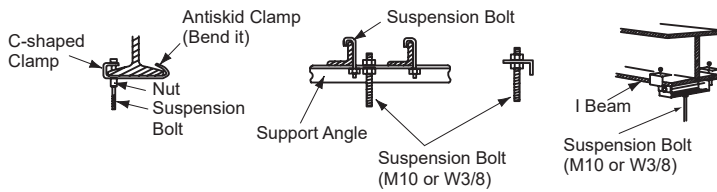

Figure 4.2 Position of Suspension Bolts

Step 2

Mount suspension bolts, as shown in Figure 4.3.

● For Steel Beam



● For Wooden Beam

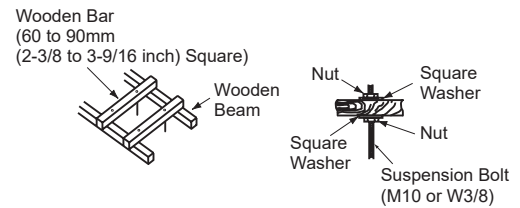

● For Concrete Slab

(1) Hole-In Anchor

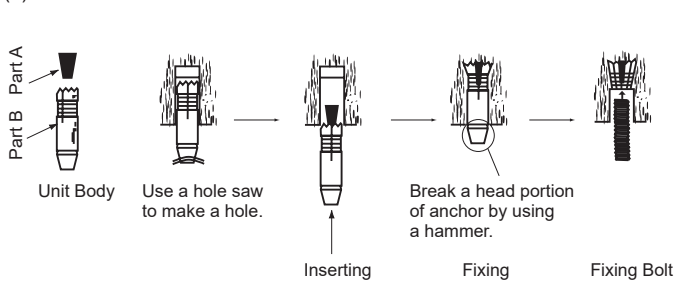

● For Reinforcing Steel

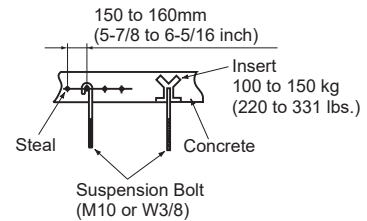

(2) Resin Capsule

Use the resin capsule within the warranty period. Resin capsules deteriorate over time and should be used within six months of the manufacturing date.

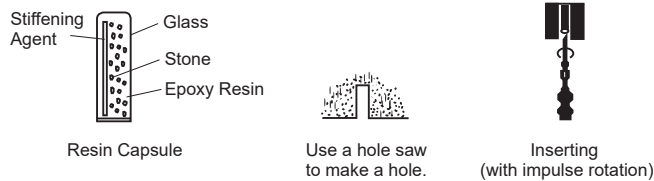

After inserting, do not rotate or put any force until resin is hardened. Required time is as shown in the table at right.

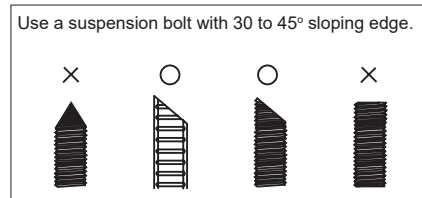

Ambient Temp.	Time
20°C (68°F)	Min. 30min.
15°C (59°F)	Min. 1hr.
10°C (50°F)	Min. 2hr.
5°C (41°F)	Min. 4hr.
0°C (32°F)	Min. 8hr.

NOTE:

- Use a suspension bolt (W3/8, Metric screw thread: M10).
- Prepare washer and nut.

Figure 4.3 Mounting of Suspension Bolts

4.4 Installation

4.4.1 Marking of the Positions of the Suspension Bolts and Wiring Connections

- (1) Mark the positions of the suspension bolts, refrigerant piping connections and wiring connection.
- (2) Installation dimensions are shown in Figure 2.1 and 2.2.

4.4.2 Mounting and Hanging the Switch Box

- (1) Place nuts and washers onto the suspension bolts before installing the Switch Box.

NOTE:

Make sure to use washers for installing the suspension bolts to the suspension brackets. Install the washer with the insulation side facing down for suspended installation applications. This way, the washers themselves remain in position on the suspension bolts during the installation phase.

Field-Supplied Parts

- * Suspension Bolt: 4-M10 or W3/8
- * Nut: 12-M10 or W3/8
- * Washer: 4-M10 or W3/8
- * Washer with Insulation: 4-M10 or W3/8

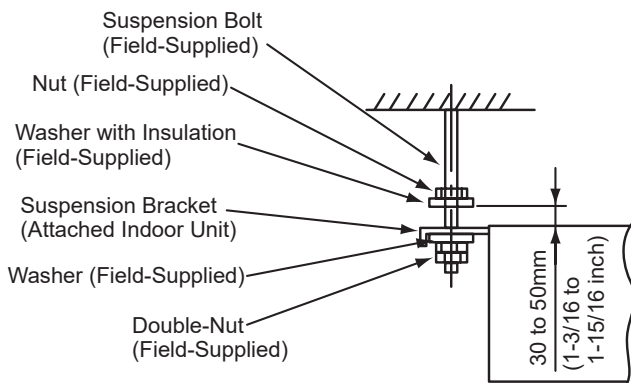

Figure 4.4 Suspension

(2) Hanging the Switch Box

- (a) Hang the Switch Box by putting hands on the bottom of the cabinet.
- (b) Insert the suspension bolt into the groove part of the suspension bracket as shown in Figure 4.5. Ensure that the washers are correctly affixed to the suspension bracket.
- (c) After the hanging work, the piping and wiring connection work is required inside the ceiling in the gap between the roof and ceiling so it is not visible. Therefore, determine the drawing direction of the pipe after selecting the installation location of the Switch Box. Before doing the hanging work, carry out the piping and wiring work up to the connecting positions.
- (d) Keep the Switch Box level to the ceiling surface. If the Switch Box is not level, a malfunction may occur.
- (e) Tighten the nuts of the suspension bolt with the suspension bracket after adjustment is completed. Adhesive must be applied to the nuts in order to prevent them from loosening.

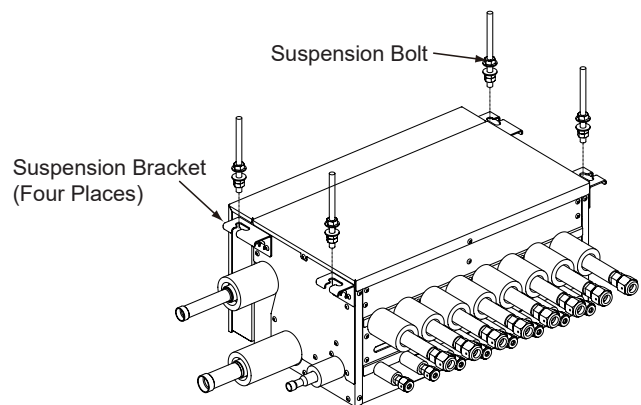

Figure 4.5 Hanging Method

5. Refrigerant Piping Work

! DANGER

Use the specified non-flammable refrigerant (R410A) for the outdoor unit in the refrigerant cycle. Do not charge material other than R410A into the unit such as hydrocarbon refrigerants (propane or something similar), oxygen, flammable gases (acetylene or etc.) or poisonous gases when installing, maintaining and moving. These flammables are extremely dangerous and may cause an explosion, a fire, and injury.

- Flaring Dimension
Perform the flaring work as shown below.

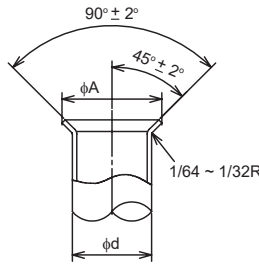

Diameter (φd)	mm (inch)	
	A	+0 -0.4(-0.02)
	R410A	
6.35 (1/4)	9.1	(0.36)
9.52 (3/8)	13.2	(0.52)
12.7 (1/2)	16.6	(0.65)
15.88 (5/8)	19.7	(0.78)
19.05 (3/4)	(*)	

- (*) It is impossible to perform the flaring work with 1/2H material. In this case, use an accessory pipe (with a flare)

5.1 Refrigerant Piping

- (1) Prepare locally-supplied copper pipes.
- (2) Select clean copper tubes making sure there is no dust or moisture inside the tubes. Before connecting pipes, blow the inside of the tubes with nitrogen or dry air, to remove any dust or foreign materials.
- (3) Select the piping size as shown in the tables below. Furthermore, check for the flare nut and flaring dimension according to the following figure and table.

- Joint Selection

When using 1/2H material and the flaring work is not available. In this instance, use a joint selected from the chart below.

Minimum Thickness of Joint mm(inch)

Diameter	R410A
6.35 (1/4)	0.5 (0.020)
9.52 (3/8)	0.6 (0.024)
12.7 (1/2)	0.7 (0.028)
15.88 (5/8)	0.8 (0.031)
19.05 (3/4)	0.8 (0.031)
22.2 (7/8)	0.9 (0.035)
25.4 (1)	0.95 (0.037)
28.58 (1-1/8)	1.0 (0.039)
31.75 (1-1/4)	1.1 (0.043)
38.1 (1-1/2)	1.35 (0.053)
41.28 (1-5/8)	1.45 (0.057)

Flare Nut Dimension B mm(inch)

Diameter	R410A
6.35 (1/4)	17 (11/16)
9.52 (3/8)	22 (7/8)
12.7 (1/2)	26 (1)
15.88 (5/8)	29 (1-1/8)
19.05 (3/4)	36 (1-7/16)

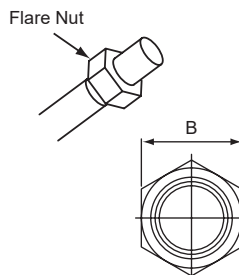

NOTE:

Do not use a joint other than those specified in the table above.

NOTICE

- Cautions for Refrigerant Pipe Work (Example)

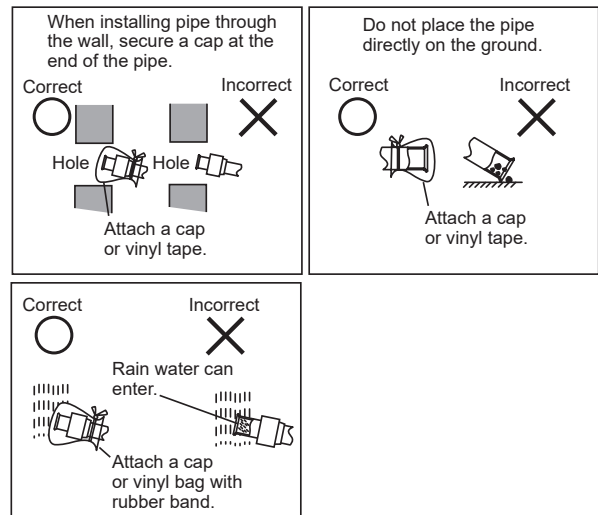

- Cautions for Piping Connection Work
 - (a) Connect the indoor/outdoor connecting pipes. Secure the pipes and do not touch other objects, such as ceilings for example. (Otherwise, abnormal sound may be heard due to the vibration of the piping.)
 - (b) Apply refrigerant oil slightly on the sheet surface of the pipe and flare nut before the flaring work. Then tighten the flare nut with the specified tightening torque using two wrenches. Always use a back-up wrench to prevent twisting of the copper piping within the unit assembly. Perform the flaring work on the liquid piping side before the gas piping side. Check the gas leakage after the flaring work.

NOTE:

Refrigerant oil is field-supplied
 [Ethereal Oil FVC50K, FVC68D (Idemitsu Kousan Co. Ltd.)]

- (c) When temperature and humidity inside the ceiling exceed 27°C(80°F) /RH, relative humidity, 80%, apply additional insulation approximately 20mm (13/16 inch) thickness to the accessory insulation. It prevents condensation on the surface of the insulation (refrigerant pipe only) and possible damage to electronic components.
- (d) Perform the air-tight leakage test 4.15MPa (601 psi) for the test pressure. Refer to the Technical Manual for the Outdoor Unit for more details.
- (e) Perform cold insulation work by insulating and taping the flare connection and reducer connection. Also insulate all the refrigerant pipes.

CAUTION

- Do not apply excessive force to the flare nut when tightening. Excessive force can result in the flare nut cracking and refrigerant leakage may occur. Use the specified tightening torque.
- For more details of the refrigerant piping work, vacuum pumping and refrigerant charge, refer to the Technical Manual for the Outdoor Unit.

Apply Refrigerant Oil.

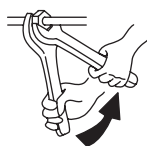
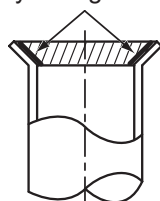

Two wrenches required to prevent damaging the copper piping.

Required Tightening Torque

Pipe Size	Tightening Torque
6.35mm (φ1/4 inch)	14 to 18 N•m (10.3 to 13.3 ft.-lbs)
9.52mm (φ3/8 inch)	34 to 42 N•m (25.1 to 31.0 ft.-lbs)
12.7mm (φ1/2 inch)	49 to 61 N•m (36.1 to 45.0 ft.-lbs)
15.88mm (φ5/8 inch)	68 to 82 N•m (50.2 to 60.5 ft.-lbs)
19.05mm (φ3/4 inch)	100 to 120 N•m (73.8 to 88.5 ft.-lbs)

5.2 Refrigerant Piping Work

Provide the refrigerant pipe in the field.

Make sure that the refrigerant pipe is connected to the same refrigerant cycle unit.

(1) Position of Piping Connection

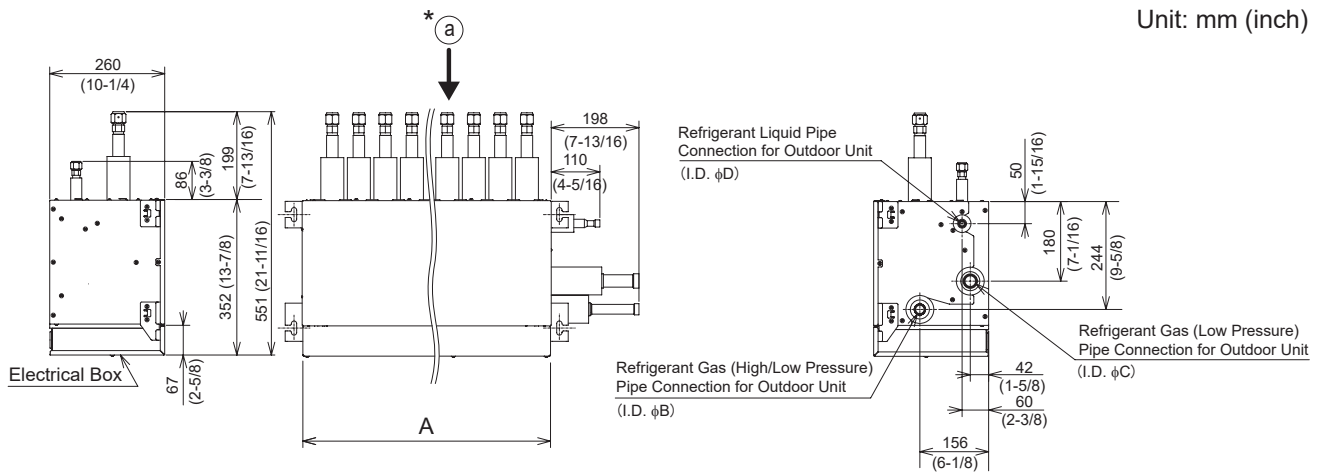

Model	Dimension A	Dimension B	Dimension C	Dimension D
HCHM-N04X	303 (11-15/16)	22.2 (7/8)	25.4 (1)	12.7 (1/2)
HCHM-N08X	543 (21-3/8)	22.2 (7/8)	28.6 (1 1/8)	12.7 (1/2)
HCHM-N12X	783 (30-13/16)	25.4 (1)	28.6 (1 1/8)	15.88 (5/8)
HCHM-N16X	1023 (40-9/32)	28.6 (1-1/8)	31.75 (1-1/4)	19.05 (3/4)

View of Indoor Unit Connecting Side ^{*}(a)

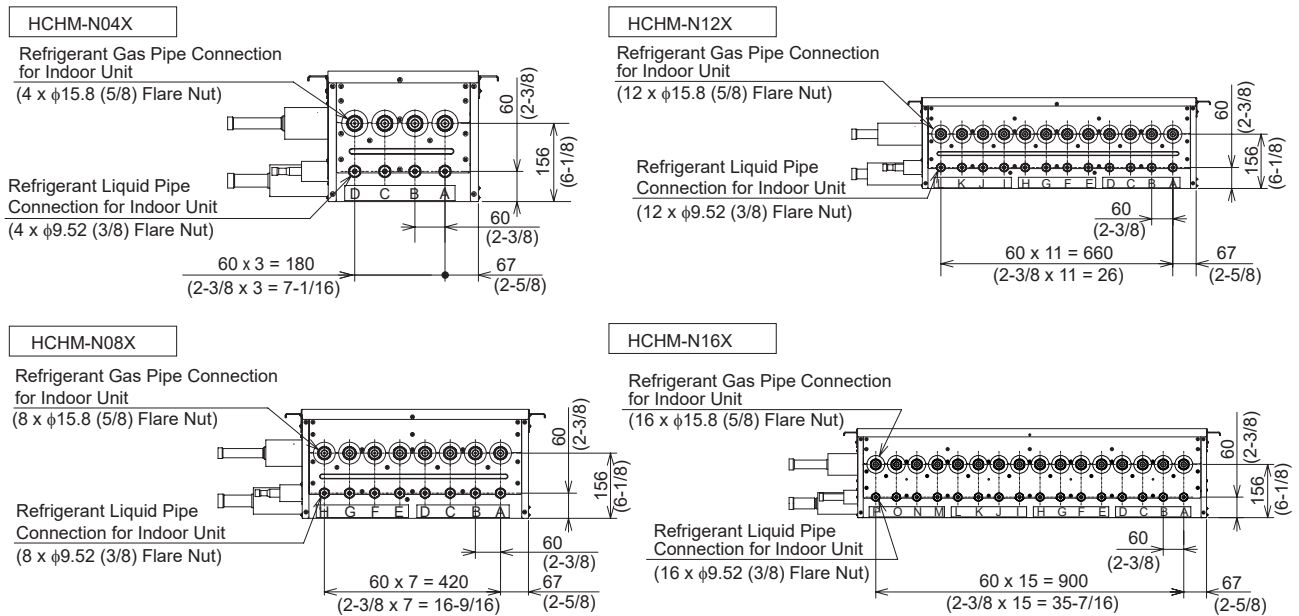

(2) Piping Work for Switch Box

Refrigerant piping size depends on the combinations with the outdoor unit. Refer to the installation and maintenance manual for the outdoor unit. Perform piping work for the Switch Box according to the following figure.

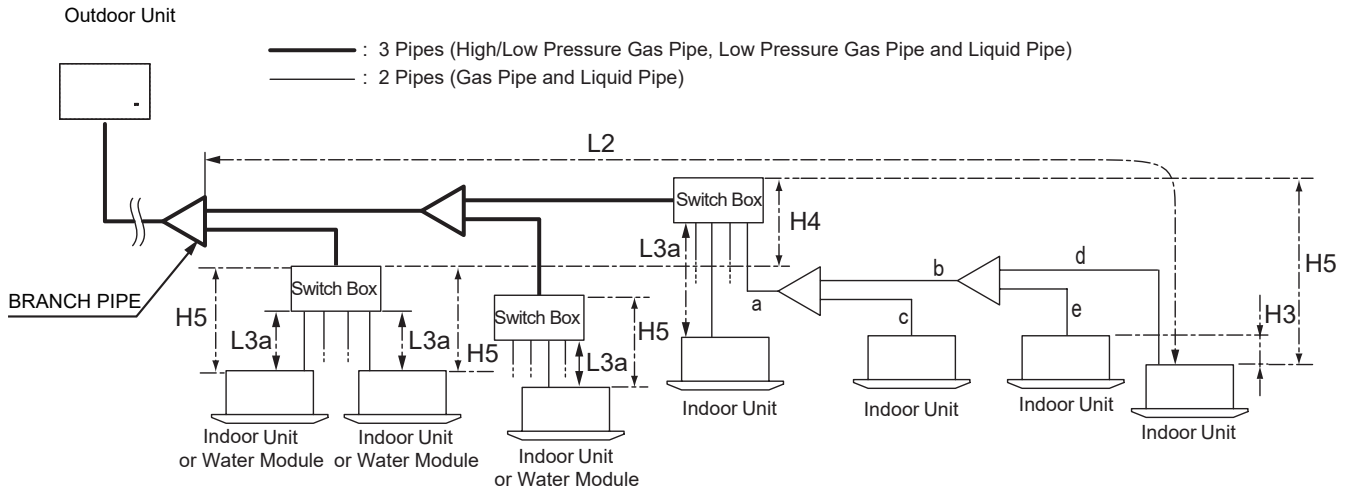

Item		Mark	Allowable Piping Length
Piping Length	Maximum Piping Length between BRANCH PIPE of 1st Branch and Terminal Indoor Unit	L2	$\leq 90\text{m (295 ft)}^1$
	Maximum Piping Length between Switch Box and Indoor Unit	L3a, a+b+d, a+b+e or a+c	$\leq 40\text{m (131 ft)}^2$
	In Case there is Branch after Switch Box, Total Piping Length from Switch Box to Each Connected Indoor Unit per Branch	a+b+c+d+e	$\leq 40\text{m (131 ft)}$
Height Difference	In Case there is Branch after Switch Box, Height Difference between Indoor Units Connected to Same Connection Port of Switch Box	H3	$< 4\text{m (13 ft)}$
	Height Difference between Switch Boxes	H4	$< 15\text{m (49 ft)}$
	Height Difference between Switch Box and Indoor Unit	H5	Refer to NOTE 3.

NOTES:

1. When the piping length from the first branch to the terminal indoor unit exceeds 40m (131 ft), there are restrictions. Refer to the installation and maintenance manual for the outdoor unit.
2. If the piping length (L3a) between each Switch Box and indoor unit is considerably longer than other indoor unit, refrigerant may not flow well, and may lessen the unit's performance compared to other models. (Recommended Piping Length: Within 15m (49 ft))
3. When the height difference between Switch Box and indoor unit is long, the performance may decrease. (Recommended Piping Length: Within 15m (49 ft))
4. Each Water Module must occupy one branch of Switch Box exclusively.

(3) Selecting Piping Size

- Select the size for the high/low pressure gas pipe, low pressure gas pipe and liquid pipe according to Table 5.1. The size depends on the indoor unit total capacity connected downstream of the Switch Box.
- As for the BRANCH PIPE branch or header branch, refer to the Technical Catalog for the Outdoor Unit.
- Perform the piping connection work for the Switch Box as shown below.

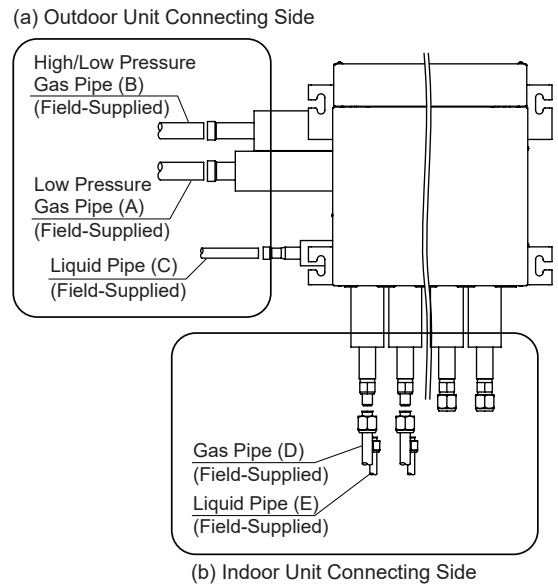

(a) Outdoor Unit Side Field Piping Size

Table 5.1 Outdoor Unit Side Field Piping Size

Connected Indoor Unit Capacity: Q kW	Low Pressure Gas Pipe (A) mm (inch)	High/Low Pressure Gas Pipe (B) mm (inch)	Liquid Pipe (C) mm (inch)
< 16.0	φ15.88 (5/8)	φ12.7 (1/2)	φ9.52 (3/8)
16.0 ≤ Q < 25.0	φ19.05 (3/4)	φ15.88 (5/8)	φ9.52 (3/8)
25.0 ≤ Q < 33.5	φ22.2 (7/8)	φ19.05 (3/4)	φ9.52 (3/8)
33.5 ≤ Q < 45.0	φ25.4 (1)	φ22.2 (7/8)	φ12.7 (1/2)
45.0 ≤ Q < 50.0	φ28.58 (1-1/8)	φ22.2 (7/8)	φ12.7 (1/2)
50.0 ≤ Q < 61.5	φ28.58 (1-1/8)	φ22.2 (7/8)	φ15.88 (5/8)
61.5 ≤ Q < 73.0	φ28.58 (1-1/8)	φ25.4 (1)	φ15.88 (5/8)
73.0 ≤ Q ≤ 85.0	φ31.75 (1-1/4)	φ28.58 (1-1/8)	φ19.05 (3/4)

NOTE:

Refer to "Position of Piping Connection" for the details of the piping connection for the Switch Box. Use field-supplied reducer in case the field piping and Switch Box piping connection does not match.

Details of changes to the piping size for connection to the Switch Box are shown below.

HCHM-N04X

Unit: mm (inch)

	Piping Connection Size for Switch Box	Required Pipe Size	Field-Supplied	Remarks
Low Pressure Gas Pipe (A)	φ25.4 (1)	φ19.05 (3/4)	OD25.4 (1) → ID19.05 (3/4)	Apply Field-Supplied Reducer (2 Size Down)
		φ22.2 (7/8)	OD25.4 (1) → ID22.2 (7/8)	Apply Field-Supplied Reducer
		φ25.4 (1)	-	-
		φ28.58 (1-1/8)	OD25.4 (1) → ID28.58 (1-1/8)	Apply Field-Supplied Reducer
High/Low Pressure Gas Pipe (B)	φ22.2 (7/8)	φ12.7 (1/2)	OD22.2 (7/8) → ID12.7 (1/2)	Apply Field-Supplied Reducer (3 Size Down)
		φ15.88 (5/8)	OD22.2 (7/8) → ID15.88 (5/8)	Apply Field-Supplied Reducer (2 Size Down)
		φ19.05 (3/4)	OD22.2 (7/8) → ID19.05 (3/4)	Apply Field-Supplied Reducer
		φ22.2 (7/8)	-	-
Liquid Pipe (C)	φ12.7 (1/2)	φ9.52 (3/8)	OD12.7 (1/2) → ID9.52 (3/8)	Apply Field-Supplied Reducer
		φ12.7 (1/2)	-	-

HCHM-N08X

Unit: mm (inch)

	Piping Connection Size for Switch Box	Required Pipe Size	Field-Supplied	Remarks
Low Pressure Gas Pipe (A)	φ28.58 (1-1/8)	φ19.05 (3/4)	OD28.58 (1-1/8) → ID19.05 (3/4)	Apply Field-Supplied Reducer (3 Size Down)
		φ22.2 (7/8)	OD28.58 (1-1/8) → ID22.2 (7/8)	Apply Field-Supplied Reducer (2 Size Down)
		φ25.4 (1)	OD28.58 (1-1/8) → ID25.4 (1)	Apply Field-Supplied Reducer
		φ28.58 (1-1/8)	-	-
		φ34.93 (1-3/8)	OD28.58 (1-1/8) → ID34.93 (1-3/8)	Apply Field-Supplied Reducer
High/Low Pressure Gas Pipe (B)	φ22.2 (7/8)	φ15.88 (5/8)	OD22.2 (7/8) → ID15.88 (5/8)	Apply Field-Supplied Reducer (2 Size Down)
		φ19.05 (3/4)	OD22.2 (7/8) → ID19.05 (3/4)	Apply Field-Supplied Reducer
		φ22.2 (7/8)	-	-
		φ25.4 (1)	OD22.2 (7/8) → ID25.4 (1)	Apply Field-Supplied Reducer
		φ28.58 (1-1/8)	OD22.2 (7/8) → ID28.58 (1-1/8)	Apply Field-Supplied Reducer (2 Size Up)
Liquid Pipe (C)	φ12.7 (1/2)	φ9.52 (3/8)	OD12.7 (1/2) → ID9.52 (3/8)	Apply Field-Supplied Reducer
		φ12.7 (1/2)	-	-
		φ15.88 (5/8)	OD12.7 (1/2) → ID15.88 (5/8)	Apply Field-Supplied Reducer
		φ19.05 (3/4)	OD12.7 (1/2) → ID19.05 (3/4)	Apply Field-Supplied Reducer (2 Size Up)

HCHM-N12X

Unit: mm (inch)

	Piping Connection Size for Switch Box	Required Pipe Size	Field-Supplied	Remarks
Low Pressure Gas Pipe (A)	$\phi 28.58$ (1-1/8)	$\phi 22.2$ (7/8)	OD28.58 (1-1/8) → ID22.2 (7/8)	Apply Field-Supplied Reducer (2 Size Down)
		$\phi 25.4$ (1)	OD28.58 (1-1/8) → ID25.4 (1)	Apply Field-Supplied Reducer
		$\phi 28.58$ (1-1/8)	-	-
		$\phi 34.93$ (1-3/8)	OD28.58 (1-1/8) → ID34.93 (1-3/8)	Apply Field-Supplied Reducer
High/Low Pressure Gas Pipe (B)	$\phi 25.4$ (1)	$\phi 19.05$ (3/4)	OD25.4 (1) → ID19.05 (3/4)	Apply Field-Supplied Reducer (2 Size Down)
		$\phi 22.2$ (7/8)	OD25.4 (1) → ID22.2 (7/8)	Apply Field-Supplied Reducer
		$\phi 25.4$ (1)	-	-
		$\phi 28.58$ (1-1/8)	OD25.4 (1) → ID28.58 (1-1/8)	Apply Field-Supplied Reducer
Liquid Pipe (C)	$\phi 15.88$ (5/8)	$\phi 9.52$ (3/8)	OD15.88 (5/8) → ID9.52 (3/8)	Apply Field-Supplied Reducer (2 Size Down)
		$\phi 12.7$ (1/2)	OD15.88 (5/8) → ID12.7 (1/2)	Apply Field-Supplied Reducer
		$\phi 15.88$ (5/8)	-	-
		$\phi 19.05$ (3/4)	OD15.88 (5/8) → ID19.05 (3/4)	Apply Field-Supplied Reducer

HCHM-N16X

Unit: mm (inch)

	Piping Connection Size for Switch Box	Required Pipe Size	Field-Supplied	Remarks
Low Pressure Gas Pipe (A)	$\phi 31.75$ (1-1/4)	$\phi 22.2$ (7/8)	OD31.75 (1-1/4) → ID22.2 (7/8)	Apply Field-Supplied Reducer (3 Size Down)
		$\phi 25.4$ (1)	OD31.75 (1-1/4) → ID25.4 (1)	Apply Field-Supplied Reducer (2 Size Down)
		$\phi 28.58$ (1-1/8)	OD31.75 (1-1/4) → ID28.58 (1-1/8)	Apply Field-Supplied Reducer
		$\phi 31.75$ (1-1/4)	-	-
High/Low Pressure Gas Pipe (B)	$\phi 28.58$ (1-1/8)	$\phi 19.05$ (3/4)	OD28.58 (1-1/8) → ID19.05 (3/4)	Apply Field-Supplied Reducer (3 Size Down)
		$\phi 22.2$ (7/8)	OD28.58 (1-1/8) → ID22.2 (7/8)	Apply Field-Supplied Reducer (2 Size Down)
		$\phi 25.4$ (1)	OD28.58 (1-1/8) → ID25.4 (1)	Apply Field-Supplied Reducer
		$\phi 28.58$ (1-1/8)	-	-
Liquid Pipe (C)	$\phi 19.05$ (3/4)	$\phi 9.52$ (3/8)	OD19.05 (3/4) → ID9.52 (3/8)	Apply Field-Supplied Reducer (3 Size Down)
		$\phi 12.7$ (1/2)	OD19.05 (3/4) → ID12.7 (1/2)	Apply Field-Supplied Reducer (2 Size Down)
		$\phi 15.88$ (5/8)	OD19.05 (3/4) → ID15.88 (5/8)	Apply Field-Supplied Reducer
		$\phi 19.05$ (3/4)	-	-

(b) Indoor Unit Side Field Piping Size

- When a branch is located downstream of the Switch Box

Connected Indoor Unit Capacity: (Q)	Gas Pipe (D)	Liquid Pipe (E)
kW	mm (inch)	mm (inch)
Q < 16.0	φ15.88 (5/8) ¹	φ9.52 (3/8) ¹
Q = 16.0	φ19.05 (3/4)	φ9.52 (3/8) ¹

1. Field flaring work is required. Refer to Section 5.1 for the flaring work.

- When a branch is not located downstream of the Switch Box

Connected Indoor Unit Capacity: (Q)	Gas Pipe (D)	Liquid Pipe (E)	Remarks
kW	inch (mm)	inch (mm)	
1.2 ≤ Q ≤ 6.3	φ12.7 (1/2)	φ6.35 (1/4)	Use accessory pipe (1) on gas pipe side and accessory pipe (2) on liquid pipe side to decrease the pipe size.
7.1 ≤ Q ≤ 16.0	φ15.88 (5/8) ¹	φ9.52 (3/8) ¹	-
Q = 22.4	φ19.05 (3/4)	φ9.52 (3/8) ¹	Use accessory pipe (3) on gas pipe side to increase the pipe size.
Q = 28.0	φ22.2 (7/8)	φ9.52 (3/8) ¹	Use accessory pipe (4) on gas pipe side to increase the pipe size.

1. Field flaring work is required. Refer to Section 5.1 for the flaring work.

NOTES:

1. When connecting the Gas Pipe (D) and Liquid Pipe (E), reuse the flare nut attached to the Switch Box.
2. When the connected indoor unit capacity is 1.2~6.3kW and the piping length exceeds 15m (49ft.), use 9.52mm (3/8 inch) for the liquid pipe.

NOTICE

In case the piping connection is not used for the indoor unit side piping connection, it must be sealed using the closed flare nut originally attached. These flare nuts have been tightened by torque specifications shown below before shipping. Ensure that they are sealed completely.

- Tightening Torque for Flare Nut before shipping

Item	Tightening Torque
Gas Pipe Flare Nut	75±7 N·m (55.3±5 ft·lbs)
Liquid Pipe Flare Nut	38±4 N·m (28.0±3 ft·lbs)

NOTICE

- In case of 8 and 10HP type indoor unit connection:**
Up to two 8 and 10HP type indoor units can be connected to the Switch Box within the “Maximum Total Capacity of All Connected Indoor Units”. Make sure to increase the pipe connection size by using the appropriate accessory pipe.
- In case of 8 and 10HP type indoor unit connection:**
Only single unit per branch is allowed to be connected.
- In case the number of indoor unit connection is less and the piping connections are left over:**
 - **Unused piping connections must be sealed using the closed flare nut originally attached.**
It is unnecessary to attach closed-end piping.
Refrigerant leakage is caused by loosened flare nuts.
Ensure that they are sealed completely.
Use specified tightening torque according to the table “Tightening Torque for Flare Nut before shipping” above.
 - **Any piping connections can be left over.**
- In case there is plan for additional indoor units in the future:**
 - **Do not plan the piping size for additional indoor units.** Ensure to select the piping again in the future.
 - **Additional indoor units can be connected only after the refrigerant is recovered.**

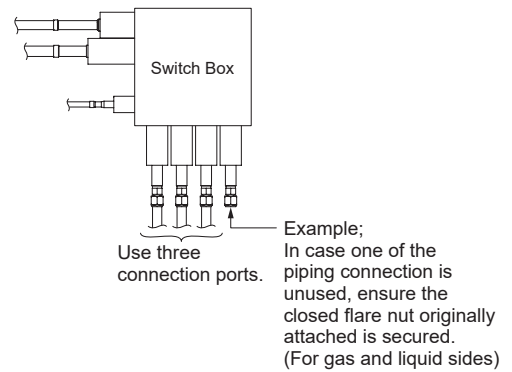

Above figure illustrate the example of HCHM-N04X.

(4) Piping Insulation

- After the air-tight leakage test, perform insulation work as shown below.

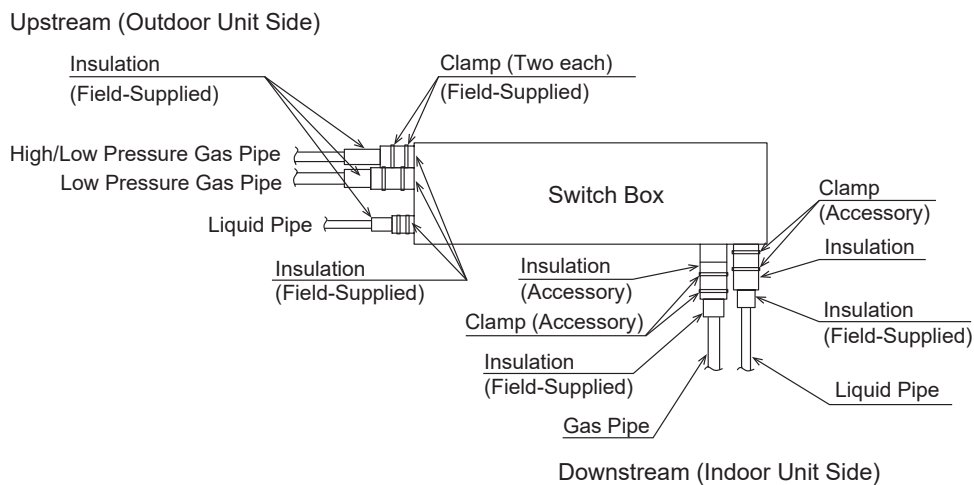

- (b) Insulate gas and liquid pipe separately using the accessory insulation material.
In the event that temperature and humidity levels inside the ceiling exceed 30°C (86°F)/RH, relative humidity 80%, apply additional insulation materials (approximately 10mm (3/8 inch) thickness) to the surface of the accessory insulation material to avoid condensation.
- (c) Perform cold insulation work by insulating and taping the flare connection and reducer connection.
Also insulate all the refrigerant pipes.

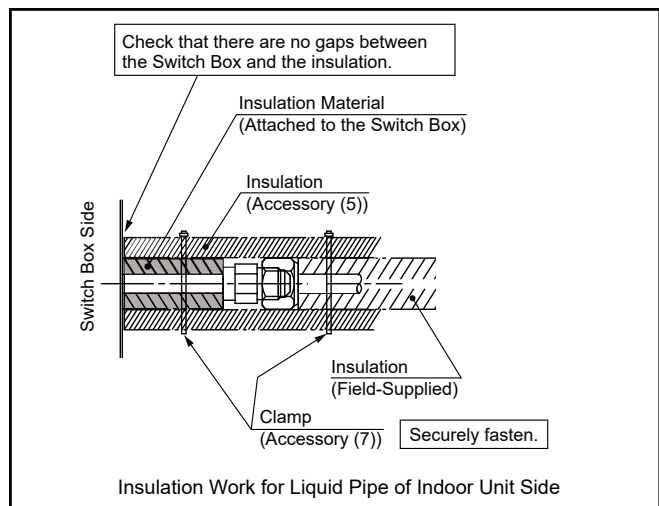
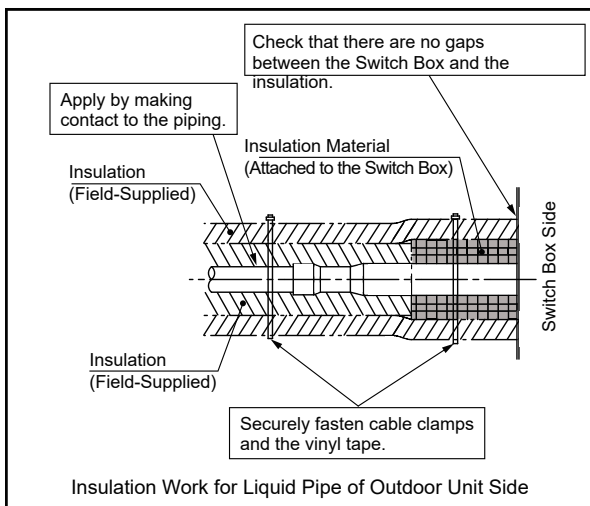
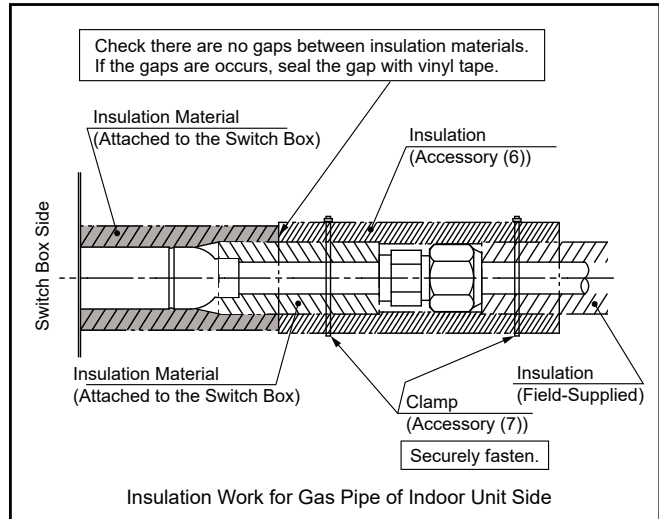
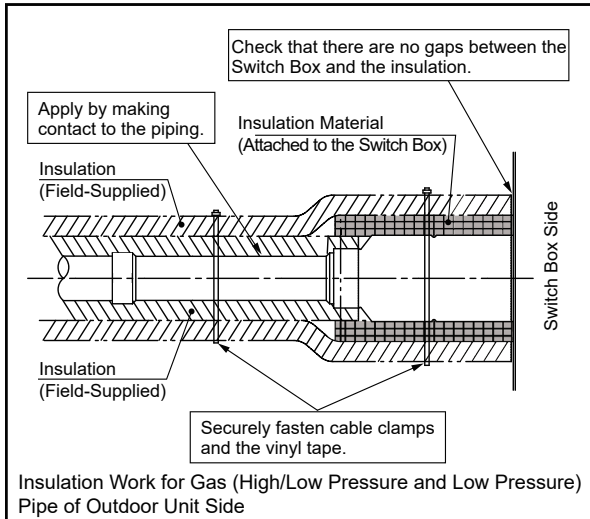

- (d) In case there are unused piping connection, ensure to apply accessory insulation material to the piping and flare connections without gaps as shown on the right figure (For gas and liquid sides)

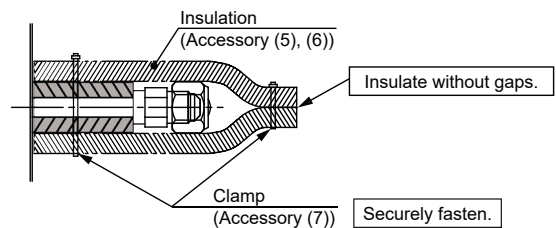

6. Electrical Wiring

WARNING

- **LOCK ALL ELECTRICAL POWER SUPPLY SWITCHES IN THE OFF POSITION BEFORE INSTALLING THE UNIT. FAILURE TO DISCONNECT POWER SUPPLY MAY RESULT IN ELECTRICAL SHOCK OR EVEN DEATH.**
- Turn off the main power switch to the Switch Box, the indoor unit and the outdoor unit before electrical wiring work or a periodical check is performed.
- Insulate electrical wiring, condensate piping, and electrical components from threats posed by burrowing animals and temperature extremes. Failure to do so can over time, deteriorate system performance.
- Secure the cables. External forces on the terminals could lead to a fire.
- Be sure to attach the cover so that it fits securely on the electrical box without any gaps. Secure the cover with screws.
- Tighten screws according to the following torque.
M4: 1.0 to 1.3 N·m (0.7 to 1.0 ft·lbs) (TB1, TB2, TB3, TB4)

CAUTION

- Wrap the field-supplied insulation around the wires, and plug the wiring connection hole with the seal material to protect the product from any condensate water or insects.
- Tightly secure the wires with the cable clamp inside the Switch Box.
- Do not connect the ground wiring to the gas pipe, condensate pipe or lightning conductor.
Gas pipe: An explosion and ignition may occur when gas leaks.
Water pipe: There is no effect of ground wiring when a hard vinyl pipe is used.
Lightning conductor: The ground electric potential abnormally increases when a lightning conductor is used.

6.1 General Check

- (1) Make sure that the field-selected electrical components (main switches, fuses, ELB (Earth Leakage Breaker), wires, conduit connectors and wire terminals) are properly selected according to the electrical data indicated in Table 6.1. Make sure that the components comply with National Electrical Code (NEC).
- (2) Communication cable must be a minimum of 18-Gauge, 2-Conductor, Stranded Copper. Shielded cable must be considered for applications and routing in areas of high EMI and other sources of potentially excessive electrical noise to reduce the potential for communication errors. When shielded cabling is applied, proper bonding and termination of the cable shield is required as per Hisense/HITACHI guidelines. Plenum and riser ratings for communication cables must be considered per application and local code requirements.
- (3) Use shielded communication cable for communication cable between the indoor and the outdoor unit (Max. 1,000m (3,281 ft)), and connect the shielded part to the ground screw in the electrical box.
- (4) Make sure that the power supply voltage is within $\pm 10\%$ of the rated voltage.
- (5) Check the capacity of the electrical wiring. If the power supply capacity is too low, the system cannot be started due to the voltage drop.
- (6) Make sure that the ground wiring is connected.

6.2 Electrical Wiring Connection

- (1) Perform the electrical wiring work for the Switch Boxes. Select the wire size according to the table below.
- (2) Pay attention to the marks on the terminal block when connecting wires for Switch Box and I.U./O.U. Refer to "Example of Electrical Wiring" for the wiring connection on the next page.

Electrical Data and Recommended Wiring, Breaker Size/1 Outdoor Unit

Model	Power Supply	Max. Running Current(A)	ELB		Fuse(A)
			Nominal Current(A)	Nominal Sensitive Current(mA)	
HCHM-N04X	220-240V ~ 50Hz 220V ~ 60Hz	-	15	30	15
HCHM-N08X					
HCHM-N12X					
HCHM-N16X					

Field Minimum Wire Sizes for Power Source

Model	Power Supply	Max. Running Current(A)	Power Source Cable Size (mm ²)	Transmitting Source Cable Size (mm ²)
			EN60335-1 ※1	EN60335-1 ※1
HCHM-N04X	220-240V ~ 50Hz 220V ~ 60Hz	-	0.75 mm ²	0.75mm ²
HCHM-N08X				
HCHM-N12X				
HCHM-N16X				

NOTES:

ELB: Earth Leakage Circuit

Breaker Remarks:

- (1) The field wiring shall be conducted according to local laws.
- (2) The sizes of above power lines shall comply with relevant standards.
- (3) The shielded wire shall be used for the control system and be grounded.
- (4) The sheathed lines shall be used for power lines and shall be copper conductors.
- (5) In case of tandem connection of power lines, the current values shall be added up to select the electric wire.

Selection According to EN60 335-1

Current i(A)	Wire Size (mm ²)
$i \leq 6$	2.5
$6 < i \leq 10$	2.5
$10 < i \leq 16$	2.5
$16 < i \leq 25$	4.0
$25 < i \leq 32$	6.0
$32 < i \leq 40$	10.0
$40 < i \leq 63$	16.0
$63 < i$	*2

*2: In the case that current exceeds 63A, do not connect cables in series.

- Example of Electrical Wiring

The following figure shows an example of electrical wiring around the Switch Boxes.

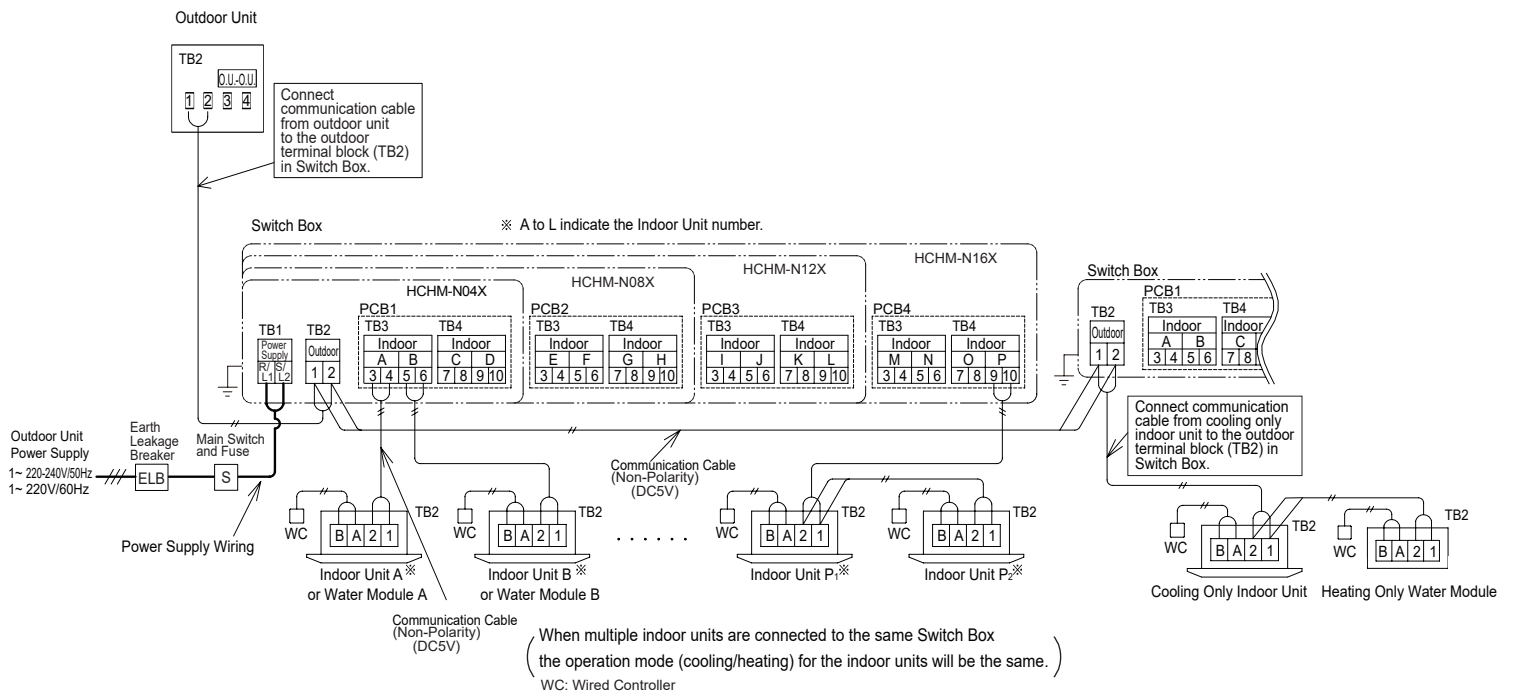

NOTES:

1. Do not apply excessive voltage to the communication cable DC5V (non-polarity) between the outdoor unit and the Switch Box, between the Switch Box and the indoor unit or between Switch Boxes.
2. Use 2-Conductor shielded communication cable for the communication cable. (Do not use 3-Conductor cable or over.)
3. Connect the communication cable for the outdoor unit to terminals "1" and "2" on TB2 in the Switch Box.
4. Connect the communication cable for the indoor unit exclusively for cooling operation to the terminal "1" and "2" on TB2 in the Switch Box.
5. For a Switch Box in the same refrigerant cycle, an electrical power supply can be supplied by one main switch.
6. Do not connect the power supply line (220-240V) to the terminal block for transmission line.
7. Connect the ground wiring for the outdoor/indoor units and Switch Box. When ground resistance is less than 100 ohms, ground wiring work should be performed by the qualified electrician.
8. Do not run the communication cables along with power supply wirings in the Switch Box. Separate communication cables from the power supply wirings.

6.3 Electrical Wiring

The electrical wiring connection for the Switch Box is shown in Figure 6.1.

- (1) Turn OFF the main power switch and take off the electrical box cover of Switch Box.
- (2) Connect the power supply wiring to L1 and L2 on the terminal block TB1, and connect ground wiring to the terminals in the electrical box.
- (3) Connect the communication cable between the outdoor unit and Switch Box to TB2 of the Switch Box. Connect the communication cable between the Switch Box and indoor unit to TB3 and TB4 of the Switch Box. Ensure that the communication cable between the Switch Box and indoor unit is connected to the same letter as piping connection. <Tightening Torque: 1.0 to 1.3 N.m (0.7 to 1.0 ft-lbs)> Refer to "Example of Electrical Wiring" for the wiring connection.
- (4) Tightly clamp the wires using the cable clamp inside the electrical box.
- (5) Make sure the communication cables outside the electrical box does not touch sharp edges by securing with clamp (accessory (7)).
- (6) Attach the electrical box cover after completing the wiring work.

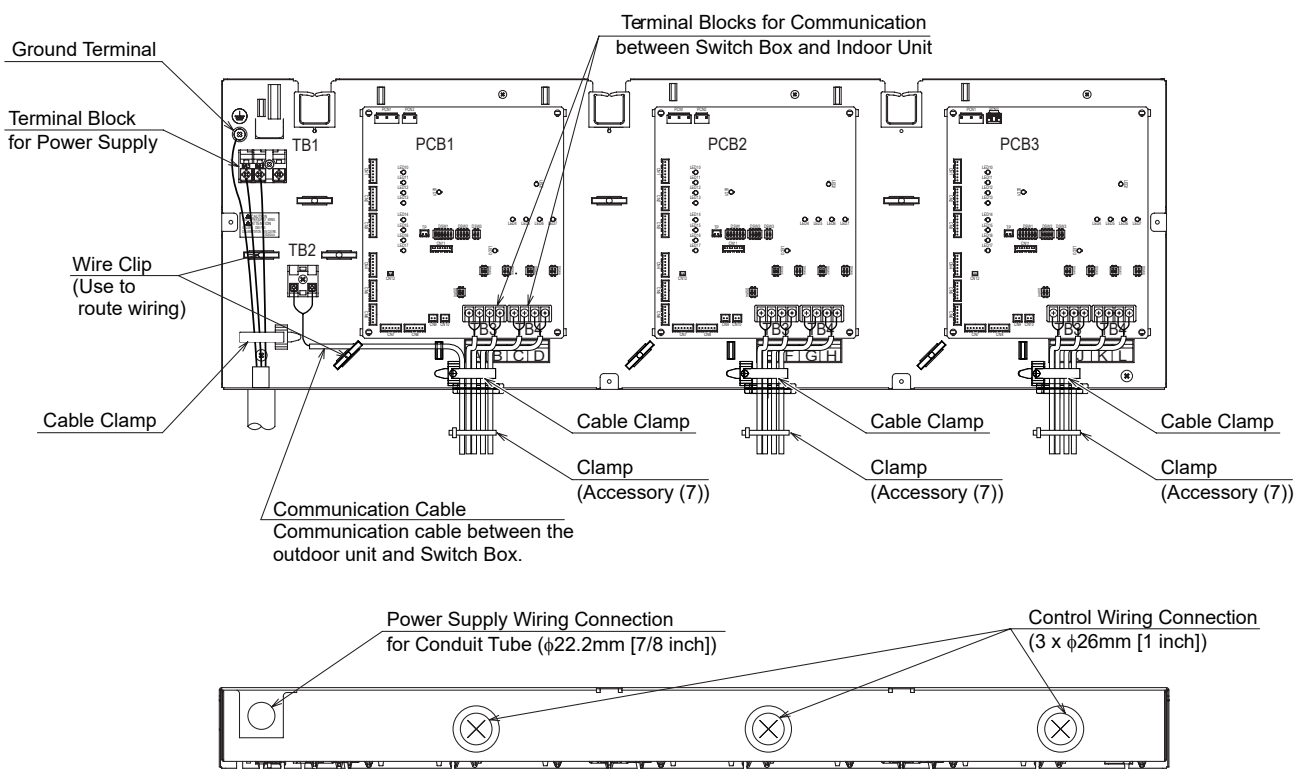

TB1: Terminal Block for Power Supply
 TB2: Terminal Block for Communication
 TB3, TB4: Terminal Block for Communication

Above figure illustrate the example of HCHM-N12X. Number of PCBs are different depending on model number. Refer to the following table.

	PCB1	PCB2	PCB3	PCB4
HCHM-N04X	○	×	×	×
HCHM-N08X	○	○	×	×
HCHM-N12X	○	○	○	×
HCHM-N16X	○	○	○	○

NOTE:

The accessory numbers are listed in Table 4.1.

Figure 6.1 Electrical Wiring Connection

6.4 Setting of DIP Switches

DSWs on the PCB1 are set before shipping as shown below and no setting is required.

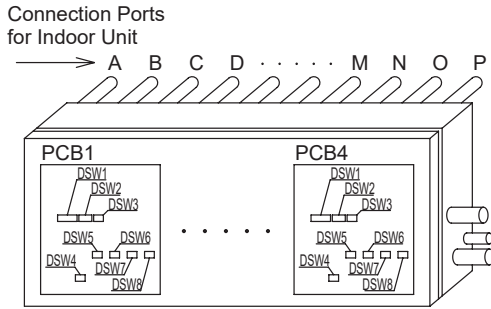

Table 6.2 Cross reference table of DIP switch settings and connection ports for indoor unit.

Models	HCHM-N04X				HCHM-N08X				HCHM-N12X				HCHM-N16X			
	A	B	C	D	E	F	G	H	I	J	K	L	M	N	O	P
Connection ports for indoor unit	A	B	C	D	E	F	G	H	I	J	K	L	M	N	O	P
PCB No.	PCB1				PCB2				PCB3				PCB4			
DSW2 Pin No.	1	2	3	4	1	2	3	4	1	2	3	4	1	2	3	4
DSW5~8	DSW5	DSW6	DSW7	DSW8	DSW5	DSW6	DSW7	DSW8	DSW5	DSW6	DSW7	DSW8	DSW5	DSW6	DSW7	DSW8

DSW1

No setting is required.

DSW2 | Connection Port Setting

This setting is required.
When the connection port is not used, turn ON the applicable pin shown in the table 6.2.

(Example)
When connection port "D" is not used, turn ON DSW2-No.4 pin on PCB1.

DSW3

No setting is required.

DSW4~8 | Fuse Recover

In the case of applying high voltage to terminals of TB2, TB3 or TB4, the 0.5A fuse on the PCB is open. In such a case, first reconnect the wiring correctly to the terminal block, and then set the No.1 pin to ON.

DSW4 (for TB2)

Factory Setting	Fuse Recover

DSW5~8 (for TB3 and TB4)

Factory Setting	Fuse Recover

NOTE

The "■" mark indicates the position of DIP switches. Figures show setting before shipment.

NOTICE

All indoor and outdoor units must be shut down prior to attempting to make DIP Switch adjustments, otherwise, the settings will not take effect.

7. Test Run

NOTICE

Refrigerant piping and connecting wires should be connected to the same refrigerant cycle system. If they are connected to the dissimilar refrigerant cycle systems, a malfunction may occur.

WARNING

- **Special Attention Regarding Refrigerant Gas Leakage**

The refrigerant R410A is non-toxic and inflammable in its original state.

However, in consideration of a state where the refrigerant leaks into the room, measures against refrigerant leaks must be taken in small rooms where the tolerable level could be exceeded.

Take countermeasures by installing ventilation devices, etc.

< Calculation of Refrigerant Concentration >

- (1) Calculate the total quantity of refrigerant R (kg) charged in the system connecting all the indoor units of rooms to be air-conditioned.
- (2) Calculate the room Volume V (m³) of each room.
- (3) Calculate the refrigerant concentration C (kg/m³) of the room according to the following equation.

$$\frac{R: \text{Total Quantity of Charged Refrigerant (kg)}}{V: \text{Room Volume (m}^3\text{)}} = C: \text{Refrigerant Concentration} \leq 0.42 \text{ (kg/m}^3\text{) for R410A}$$

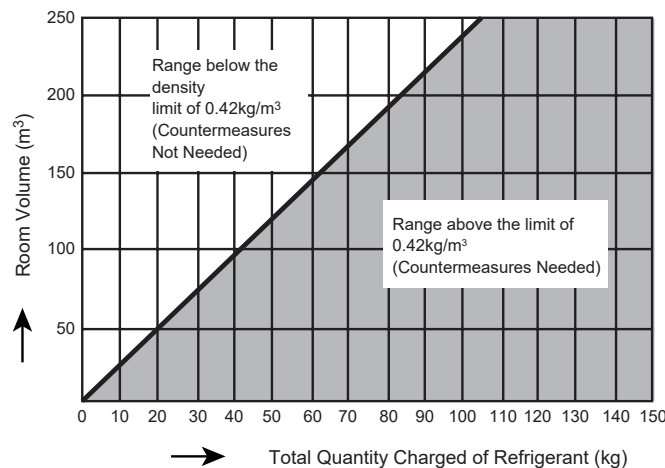

Perform a test run according to the “Installation and Maintenance Manual” of the outdoor unit.

WARNING

- **Do not operate the system until all the check points are cleared.**
 - (A) Check to ensure that the electrical resistance is more than 1 megohm by measuring the resistance between ground and the terminal block in the electrical box. If not, do not operate the system until the electrical leakage is found and repaired.
 - (B) Check to ensure that the stop valves of the outdoor unit are fully opened, and then start the system.
 - (C) Apply power to the outdoor unit(s) at least 12 hours prior to operation of the system for preheating of the compressor oil.
- **Pay attention to the following items while the system is running.**
 - (A) Do not touch any of the parts by hand at the discharge gas side, since the compressor chamber and the pipes at the discharge side are heated higher than 90°C (194°F).

8. Safety and Control Device Setting

Switch Box

Model		HCHM-N04X, HCHM-N08X, HCHM-N12X, HCHM-N16X
For Control Circuit Fuse	A	5

Qingdao Hisense Hitachi Air-conditioning Systems Co., Ltd.

Add: No. 218, Qianwangang Road, Economic & Technical
Development Zone, Qingdao, P.R. China