

STORINGSLIJST RAC

Error Code

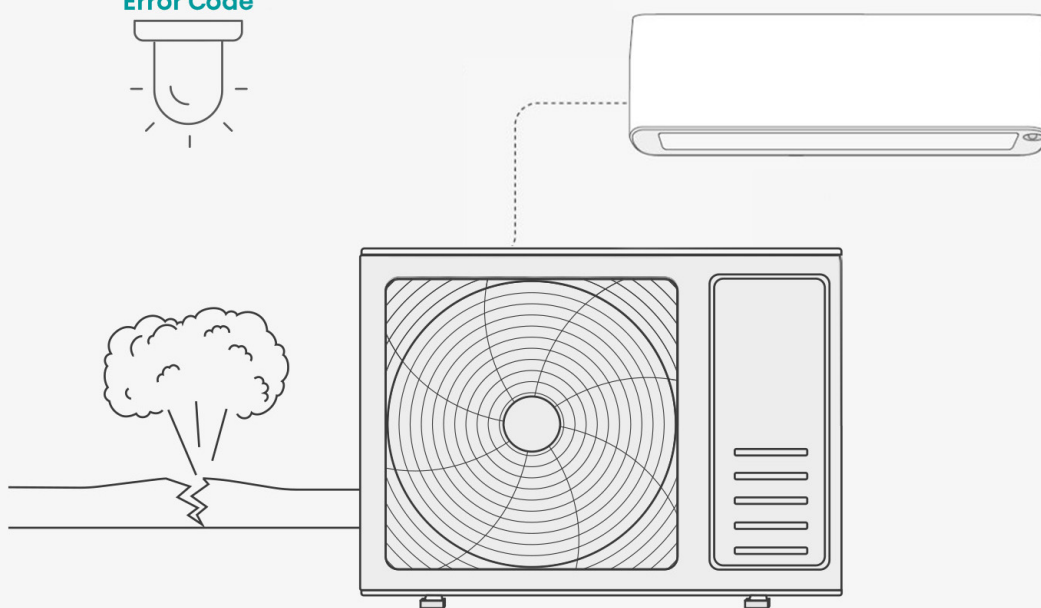

Hisense Room Air Conditioners (RAC) zijn ontworpen om een breed scala aan toepassingen te bedienen, variërend van slaapkamers in particuliere woningen tot kantooromgevingen. Met geavanceerde DC-invertertechnologie en een eigentijds en stijlvol ontwerp biedt Hisense efficiënte oplossingen voor het handhaven van comfortabele binnenomstandigheden. Een belangrijk kenmerk van de RAC-lijn is het gebruik van het koelmiddel R32, wat bijdraagt aan zowel de prestaties als de milieuvriendelijkheid van de warmtepompen.

Om een probleemloze werking van de Hisense RAC-systemen te waarborgen, is het essentieel om bekend te zijn met de storingscodes die het systeem kan genereren. Deze codes fungeren als waardevolle diagnostische hulpmiddelen om snel en nauwkeurig eventuele problemen te identificeren en op te lossen.

In geval van een storingscode raden we aan de Hisense-servicehandleiding te raadplegen voor specifieke instructies met betrekking tot de betreffende code. Indien nodig moet gekwalificeerd personeel worden geraadpleegd voor reparaties en onderhoud.



8.Trouble Shooting

8-1. Error Code Table

1.Indication on the outdoor unit:

When the unit has the following trouble and the compressor stops running, The LED of outdoor control board will show the error sequence automatically:

NOTE: ★: LIGHT O: FLASH ×: OFF

Error code	Outdoor Failure Description	LED1	LED2	LED3	the root cause my be one of the following
Mark description: the lights flash every second for the following faults					
	Normal	×	×	×	
	Outdoor coil temperature sensor in trouble	★	×	★	a. the outdoor coil sensor connect loose; b. the outdoor coil temperature sensor is failure; c. the outdoor control board is failure
	Compressor exhaust temperature sensor in trouble	★	×	×	a. the compressor exhaust temperature sensor connect loose; b. the compressor exhaust temperature sensor is failure; c. the outdoor control board is failure
	Communication failure between the indoor unit and outdoor unit	×	×	O	a. the communication cable connect loose; b. the communication cable is failure; c. the connection between the filter board and the outdoor control board is incorrect or loose; d. the connection between the filter board and the terminal is incorrect or loose; e. the indoor control board is failure; f. the PFC board is failure; g. the power board is failure; h. the outdoor control board is failure.
	Current overload protection	★	O	×	a. the fan motor run abnormally; b. the condenser or and evaporator is dirty; c. the air inlet and outlet is abnormally
	Maximum current protection	★	O	★	a. the outdoor control board is short circuit; b. the drive board is short circuit; c. the other components is short circuit
	Communication trouble between outdoor unit and driver	×	★	★	a. the connection wires connect loose b. the outdoor board or drive board is failure;
	Outdoor EEPROM in trouble	★	★	★	a. he EEPROM chip is loose; b. the EEPROM chip inserted with opposite direction;

					c. the EEPROM chip is failure
	Compressor exhaust temperature too high protection	×	○	★	a. the compressor exhaust temperature sensor is failure; b. the refrigerant of the unit is not enough
	Outdoor ambient temperature sensor in trouble	★	★	×	a. the outdoor ambient temperature sensor connect loose; b. the outdoor ambient temperature sensor is failure; c. the outdoor control board is failure
	Compressor shell temperature too high protection	×	★	○	a. the compressor exhaust temperature sensor connect loose b. the refrigerant of the unit is not enough
	Anti-freeze protection with cooling or overload protection with heating in indoor unit	×	○	○	a. the indoor coil temperature sensor connect loose; b. the indoor coil temperature sensor is failure; c. the indoor control board is failure d. the refrigerant system is abnormal.
	Compressor drive in trouble	○	×	○	a. the outdoor drive board is failure; b. the compressor is failure c. the outdoor control board is failure
	Outdoor fan motor locked rotor protection	○	○	★	a. the connection of the outdoor fan motor is loose; b. there are something block the outdoor fan; c. the fan motor is failure; d. the outdoor control board is failure
	Outdoor coil anti-overload protection with cooling	×	★	×	a. the refrigerant is too much; b. the outdoor fan motor is failure; c. the outdoor fan is broken; d. the condenser is dirty; e. the air inlet and air outlet of the indoor unit and the outdoor unit is not normally

	IPM module protection	×	○	×	<p>a. The IPM board is failure;</p> <p>b. The outdoor fan is broken;</p> <p>c. The outdoor fan motor is failure;</p> <p>d. The outdoor fan has been blocked ;</p> <p>e. The condenser is dirty;</p> <p>f. The outdoor unit has been installed without standard.</p>
	PFC protection	○	×	×	<p>a. the PFC is failure;</p> <p>b. the outdoor drive board is failure</p>
	Compressor pre heating process	○	★	○	it is normal mode in cold weather
	Chip in outdoor board in trouble	★	×	○	<p>a. Using the wrong drive board;</p> <p>b. Using the wrong compressor.</p>
	AC voltage higher or lower protection	★	★	○	<p>a. the supply voltage is higher or lower than normal;</p> <p>b. the inner supply voltage of the unit is higher or lower than normal</p>
	DC compressor start failure	○	○	×	<p>a. the outdoor drive board is failure;</p> <p>b. the compressor is failure</p>
	Outdoor ambient temperature too low protection	★	○	○	a. Outdoor ambient temperature too low
Mark description: the lights flash every two seconds for the following faults					
	Protection against overheated outdoor radiator	○	×	×	<p>a. Radiator sensors fail</p> <p>b. Detection circuit of the sensor on the control panel fails</p>
	Protection of the system against too high pressure	○	○	×	<p>a. The pressure switch fails</p> <p>b. The pressure detection switch on the control panel fails</p> <p>c. The measured value of the system pressure exceeds the limit</p>
	protection of the system abnormal Communication trouble between outdoor PCB and outdoor fresh air humidification PCB	×	○	★	a. Check whether the outdoor valves are opened.
	The failure for outdoor fresh air humidification PCB	○	★	★	<p>a. the connection wires connect loose</p> <p>b. the outdoor PCB or fresh air humidification PCB is failure;</p>
		○	★	○	<p>a. the connection wires connect loose</p> <p>b. the fresh air humidification PCB is failure;</p>

When the compressor is in operation:

Mark description: ★: Light O: Flash ×: Off; the flash cycle is 1S				
No.	LED1	LED2	LED3	Reasons for the current operating frequency of the compressor is limited
1	O	O	O	Normal frequency rising and decreasing, no limitation
2	×	×	★	Frequency decreasing or prohibition of frequency rising caused by over-current
3	×	★	★	Frequency decreasing or prohibition of frequency rising caused by anti-freezing of refrigeration or anti-overload in heating
4	★	×	★	Frequency decreasing or prohibition of frequency rising caused by too high compressor discharge temperature
5	★	★	★	Operation at fixed frequency (in the case of capability measuring or compulsory operation at fixed frequency)
6	O	×	×	Protective frequency decreasing against outdoor overload (overpower, over frequency conversion rate, over torque, detection of DC under-voltage)
7	★	×	×	Frequency decreasing caused by indoor and outdoor communication fault
8	×	★	O	Frequency decreasing or prohibition of frequency rising protection against overload of outdoor coiled pipe
9	×	★	×	Frequency decreasing or prohibition of frequency rising for power-saving when it is being used simultaneously with other appliances

2.Indication by the indoor unit:

2.1.The 7-segment tube of the indoor display board will show the error code automatically when the unit has the following trouble:

Error code	Remark: ★Light o Flash x OFF		
	Content	Remark	The root cause is may be one of the following
EA	the error code will display when the communication between display board and control board have in trouble		a. The connection between the display board and control board is loose; b. The indoor control board is failure. c. The wiring of the display board is failure.

2.2.When the unit has the following trouble and the compressor stops running, press the sleep button on the remote controller for 4 times in ten seconds and the 7-segment tube of the display board will show the error code as the following, if two malfunction happened at the same time, it need press the sleep button for 4 times again, the LED will show the other error code.

Refer to the remote controller which the sleep key can set into 4 different combination ways (Hisense's new design remote controller), when using to check the error codes need exit all the sleep mode first and then press the sleep button 10 times in ten seconds instead of 4 times.

Error code	Content	The root cause is may be one of the following
No error	Normal	
1	The failure for temperature sensor of outdoor coil	a. The outdoor temperature sensor loose; b. the outdoor temperature sensor is failure; c. The indoor control board is failure
2	Compressor exhaust temperature sensor in trouble	a. the compressor exhaust temperature sensor connect loose; b. the compressor exhaust temperature sensor is failure; c. the outdoor control board is failure
5	IPM module protection	a. The IPM board is failure; b. The outdoor fan is broken; c. The outdoor fan motor is failure; d. The outdoor fan has been blocked ; e. The condenser is dirty; f. The outdoor unit has been installed without standard.
6	AC voltage higher or lower protection	a. the supply voltage is higher or lower than normal; b. the inner supply voltage of the unit is higher or lower than normal
7	Communication failure between the indoor unit and outdoor unit	a. the communication cable connect loose; b. the communication cable is failure; c. the connection between the filter board and the outdoor control board is incorrect or loose; d. the connection between the filter board and the terminal is incorrect or loose; e. the indoor control board is failure; f. the PFC board is failure; g. the power board is failure; h. the outdoor control board is failure.
8	Current overload protection	a. the fan motor run abnormally; b. the condenser and evaporator is dirty; c. the air inlet and outlet is abnormally
9	Maximum current protection	a. the outdoor control board is short circuit; b. the drive board is short circuit; c. the other components is short circuit
10	Communication trouble between outdoor unit and driver	a. the connection wires connect loose b. the outdoor board or drive board is failure;
11	Outdoor EEPROM in trouble	a. the EEPROM chip is loose; b. the EEPROM chip inserted with opposite direction; c. the EEPROM chip is failure
12	Outdoor ambient temperature too low or too high protection	Outdoor ambient temperature too low or too high

13	Compressor exhaust temperature too high protection	a. the compressor exhaust temperature sensor is failure; b. the refrigerant of the unit is not enough
14	Outdoor ambient temperature sensor in trouble	a. the outdoor ambient temperature sensor connect loose b. the outdoor ambient temperature sensor is failure; c. the outdoor control board is failure
15	Compressor shell temperature too high protection	a. the compressor exhaust temperature sensor connect loose b. the refrigerant of the unit is not enough
16	Anti-freeze protection with cooling or overload protection with heating in	a. the indoor coil temperature sensor connect loose; b. the indoor coil temperature sensor is failure; c. the indoor control board is failure d. the refrigerant system is abnormal.
17	PFC protection	a. the PFC is failure; b. the outdoor drive board is failure
18	DC compressor start failure	a. the outdoor drive board is failure; b. the compressor is failure
19	Compressor drive in trouble	a. the outdoor drive board is failure; b. the compressor is failure c. the outdoor control board is failure
20	Outdoor fan motor locked rotor protection	a. the connection of the outdoor fan motor is loose; b. there are something block the outdoor fan; c. the fan motor is failure; d. the outdoor control board is failure
21	Outdoor coil anti-overload protection with cooling	a. the refrigerant is too much; b. the outdoor fan motor is failure; c. the outdoor fan is broken; d. the condenser is dirty; e. the air inlet and air outlet of the indoor unit and the outdoor unit is not normally
22	Compressor pre heating process	it is normal mode in cold weather
23	There is a leak in the product (suitable for some models)	a. There is a leak in the indoor b. There is a leak in the outdoor c. There is a leak in the connecting pipe
24	Chip in outdoor board in trouble	a. Using the wrong drive board; b. Using the wrong compressor.
26	Overheated outdoor radiator	a. Radiator sensor fails b. Detection circuit of the sensor on the control panel fails
27	Protection against too high system pressure	a. The pressure switch fails b. The pressure detection switch on the control panel fails c. The measured value of system pressure exceeds the limit

33	The failure for temperature sensor of indoor room	a. The indoor room temperature sensor loose; b. The indoor room temperature sensor is failure; c. The indoor control board is failure.
34	The failure for temperature sensor of indoor coil temperature	a. The indoor coil temperature sensor loose; b. The indoor coil temperature sensor is failure; c. The indoor control board is failure.
36	Communication failure between the indoor unit and outdoor unit	a. the communication cable connect loose; b. the communication cable is failure; c. the connection between the filter board and the outdoor control board is incorrect or loose; d. the connection between the filter board and the terminal is incorrect or loose; e. the indoor control board is failure; f. the PFC board is failure; g. the power board is failure; h. the outdoor control board is failure.
38	Indoor EEPROM failure	a. The EEPROM chip loose; b. The indoor control board is failure
39	Indoor fan motor run abnormally	a. There are something block the indoor fan motor; b. The fan motor cord connect loose; c. The fan motor is failure; d. The indoor control board is failure
41	The failure for Indoor grounding protective	The indoor control board is failure
50	Fresh air failure (suitable for some models)	a. The fresh air motor is failure; b. the connecting line is loose c. The indoor control board is failure.
70	Light sensation failure (suitable for some models)	a. The display control board is failure; b. the connecting line is loose c. The indoor control board is failure.
74	CO2 failure (suitable for some models)	a. The sensor is failure; b. the connecting line is loose c. The indoor control board is failure.

The failure is detected when the room temperature sensor broken or shorted over 5 sec.

The failure is detected when the temperature sensor of heater exchange broken or shorted over 5 sec.

The failure is detected when each setting data is not match after the EEPROM self-check two times.

The failure is occur when the grounding signal is not detected after the appliance power ON.

8-2. Test the jumper terminals

Note:

When the whole machine is powered up, if the external unit does not work, to rule out the communications failures, adopt screening method such as short circuit on the jumper terminals to see if the external unit can be started normally or similar method.



There are two blue terminals on the outdoor control panel, as shown above.

Application: Short out the terminals, and power up the outdoor unit, then the outdoor unit may run independently. It can be determined that there is no internal and external communication faults.

When the environment temperature is lower than 18°C, you can't run the unit under the cool mode, but if you need run the unit at this moment, such as add the gas or do more test, at this moment you can use this function,

Under this function, the outdoor motor and compressor will be forced to run until reaching a fixed frequency (general is 50~55Hz).

8-3. Trouble Diagnosis of Protection

Protection diagnosis of the complete machine (all types of protection during operation, i.e. under-voltage, over-voltage and overcurrent protection)

Note: List all types of protection that may occur to the complete machine and describe the conditions and signs of the start, course and end of such protection.

Voltage protection

Protection against AC input over-voltage/under-voltage

1. Conditions for protection against AC input over-voltage/under-voltage:

If the input AC voltage is greater than “protective over-voltage value” or less than “protective under-voltage value” for five seconds, over-voltage/under-voltage protection starts.

2. Protection actions against AC input over-voltage/under-voltage

The system stops operation.

3. Conditions for ending AC input over-voltage/under-voltage:

If the input AC voltage is lower than “the protective over-voltage value” -10V, or higher than “the protective under-voltage value” +10V, the over-voltage/under-voltage protection will be released.

Current protection:

1. Protection against over-current

Conditions for over-current protection: if the current is equal to or greater than “current value for starting the refrigeration current protection (E2 value)” for six seconds, over-current protection starts.

Protection actions against over-current: indoor display screen and outdoor indicator give indications, the

compressor and outdoor fan stop, but indoor fan runs normally.

Condition for ending over-current protection: when the current drops below “current value for releasing the refrigeration current protection (E2 value)”, over-current protection will be released.

2.Frequency decreasing for over-current

Conditions for over-current **frequency decreasing**: if the current is equal to or greater than “current value for starting the refrigeration current protective frequency decreasing (E2 value)”, over-current **frequency decreasing** starts.

Over-current **frequency decreasing** actions: the compressor will decrease frequency at rate of (E2 value)Hz/S. The indoor and outdoor fans run.

Conditions for ending over-current **frequency decreasing**: when the current drops below “current value for starting the refrigeration current protective prohibition of frequency rising (E2 value)”, over-current under-clocking will be released.

3.Prohibition of frequency increasing of compressor exhausting

Conditions for prohibition of frequency rising of compressor discharge

Condition 1: in the case of frequency decreasing of compressor discharge, the discharge temperature of the compressor drops below X4°C.

Condition 2: in normal operation, the discharge temperature of compressor reaches X5°C.

Either of the above two conditions is met, prohibition of frequency rising of compressor discharge begins.

Actions relates to prohibition of frequency rising of compressor discharge: the frequency of compressor maintains at the current level, which may decrease as the case requires while cannot rise. The indoor and outdoor fans run.

Condition for ending prohibition of frequency rising of compressor discharge: if the temperature of compressor discharge drops below X6°C, prohibition of frequency rising of compressor discharge will be released.

4. Prohibition of frequency for anti-overload of outdoor coiled pipe

Condition for anti-overload prohibition of frequency of outdoor coiled pipe: in the case of anti-overload frequency decreasing of outdoor coiled pipe, anti-overload prohibition of frequency of the unit begins when the temperature of outdoor coiled pipe drops below “the anti-overload frequency decreasing temperature of outdoor coiled pipe”.

Actions relates to anti-overload prohibition of frequency of outdoor coiled pipe: the frequency of compressor maintains at the current level, which may decrease as the case requires while cannot rise. The indoor and outdoor fans run.

Condition for ending anti-overload prohibition of frequency of outdoor coiled pipe: if the temperature of outdoor coiled pipe drops below “temperature to release the anti-overload state of outdoor coiled pipe”, anti-overload prohibition of frequency of outdoor coiled pipe will be released.

8-4. Trouble Diagnosis of Compressor

Judging the connecting terminals of inverter compressor:

It is impossible to identify terminals U, V and W of inverter compressor with multi-meter. Just connect the terminals in the same way as the original unit when replacing the compressor. A wrong connection will lead to reverse and loud noise of the compressor.

Resistance of compressor coil:

Measure the resistance between any two terminals, which are about a few Ohms, three phases having the same resistance.

8-5. Trouble Diagnosis of Electric Filter Board

Visual examination: as the circuit is simple, the connection may be checked visually to see whether any loose or poor connection.

Voltage test: the voltage at the input end shall be the same as the voltage at the output end.

8-6. Trouble Diagnosis of Electric Communication

Step one: to determine whether the connecting cables and tether cables of indoor/outdoor units are correctly wired. If not, change wiring order and test connection.

Step two: to determine whether there is loose connection.

Fasten the connection in the case of loose connection and then conduct verification.

Step three: measure the voltage between SI and N with multi-meter and see whether the voltage fluctuates between 0V and 24V. Please directly replace indoor and outdoor control boards if there are not voltage fluctuations.

8-7. Diagnosis and Solution

1.

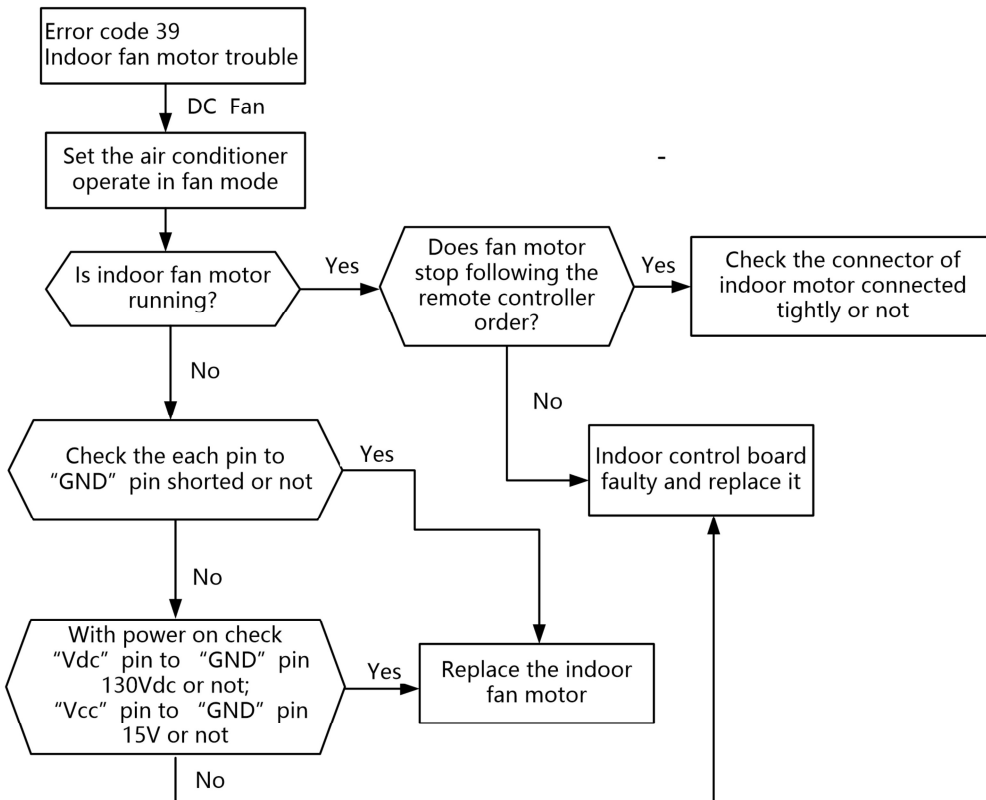
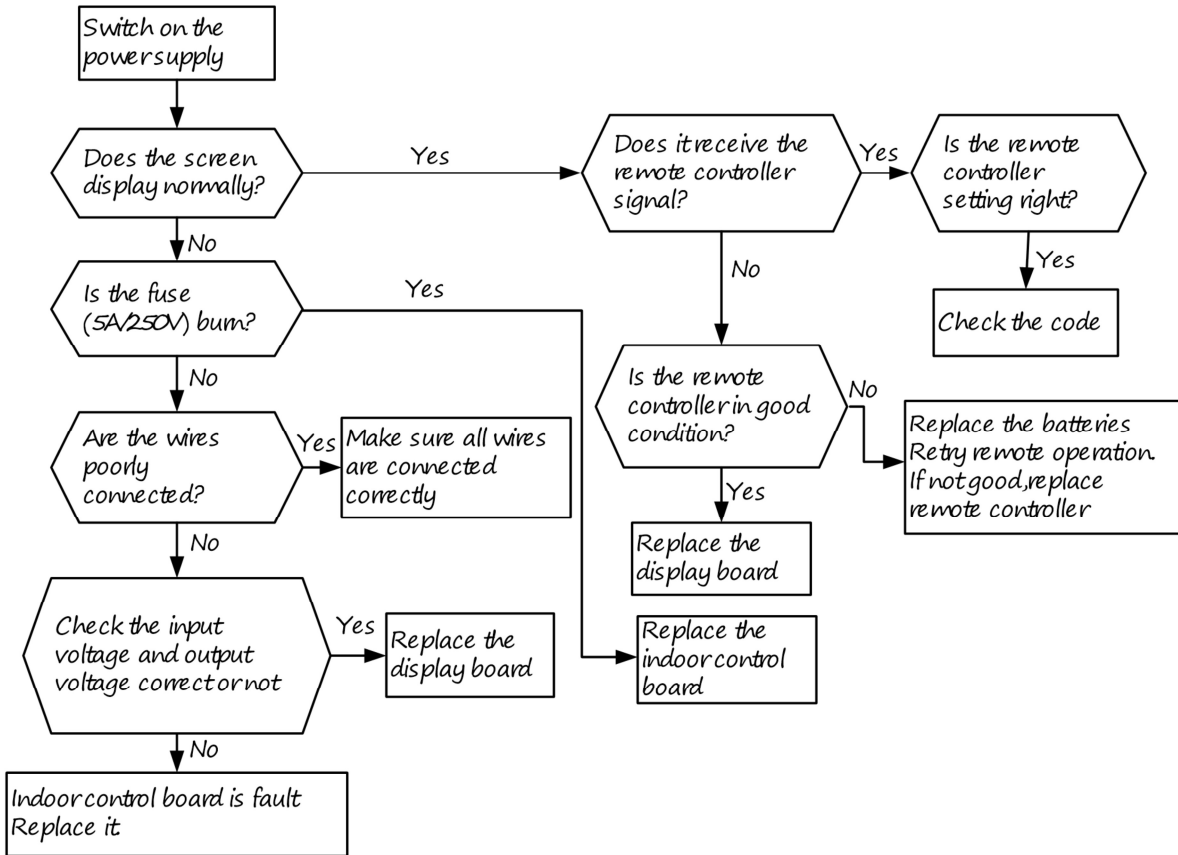

2.

DC Fan test point:



3.

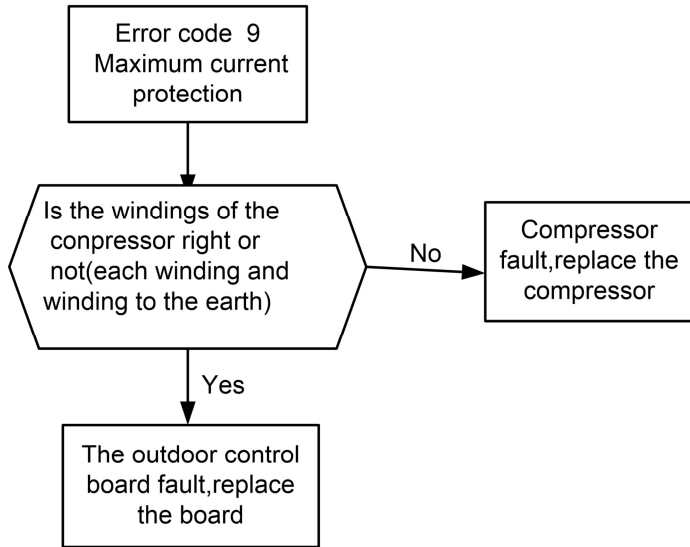

4.

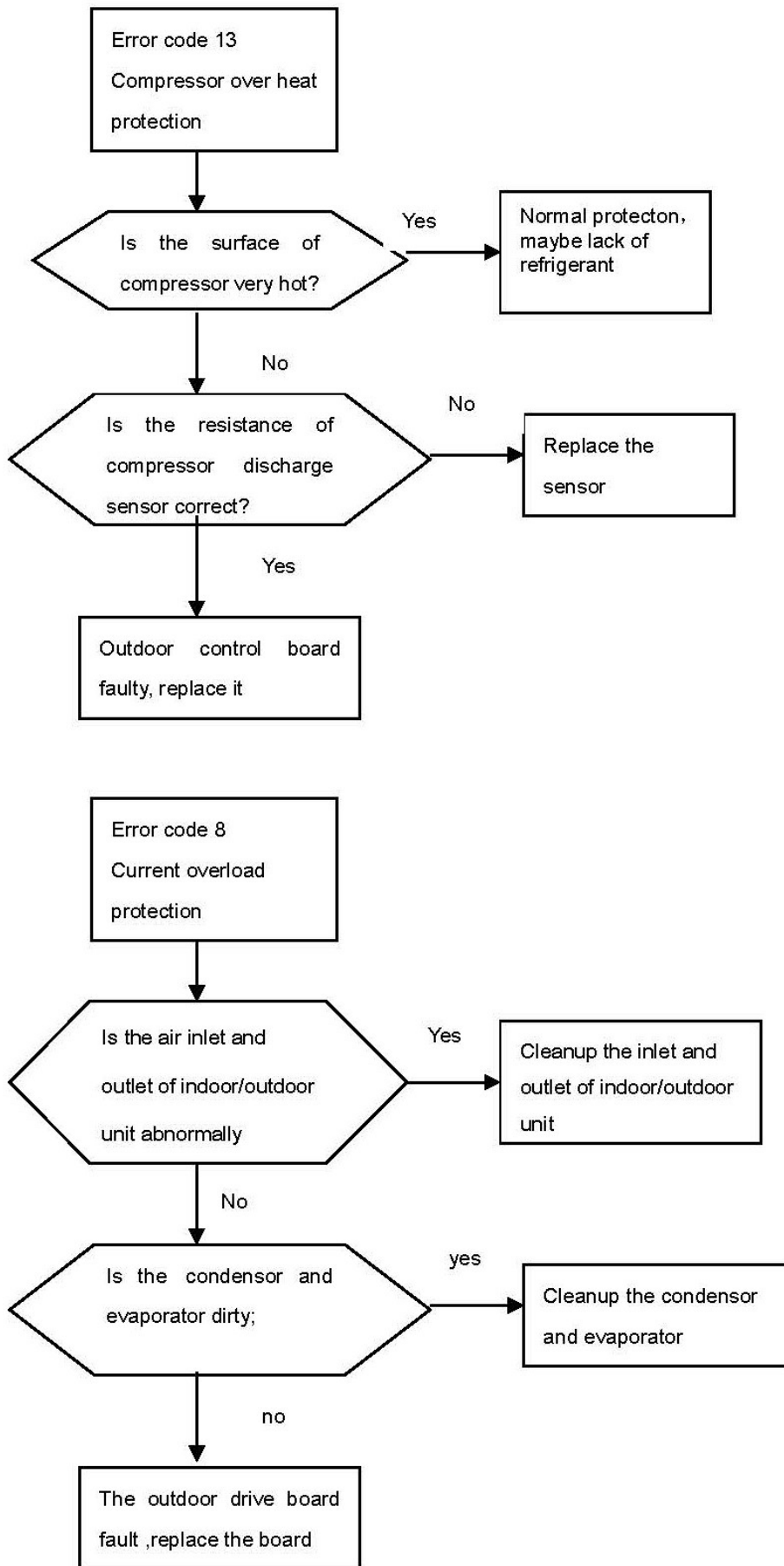

5.

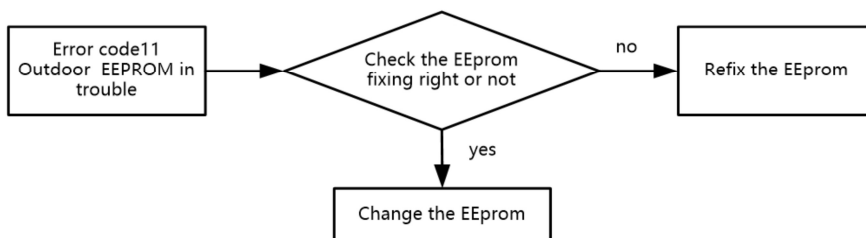
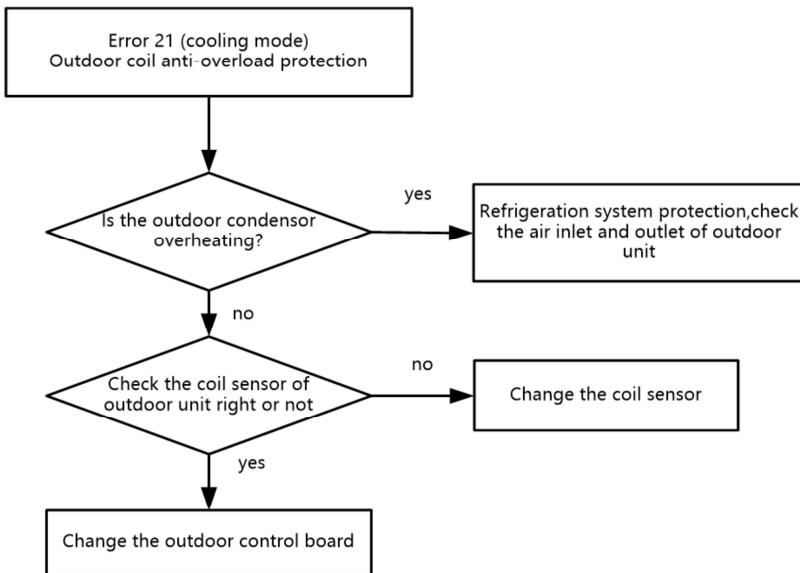
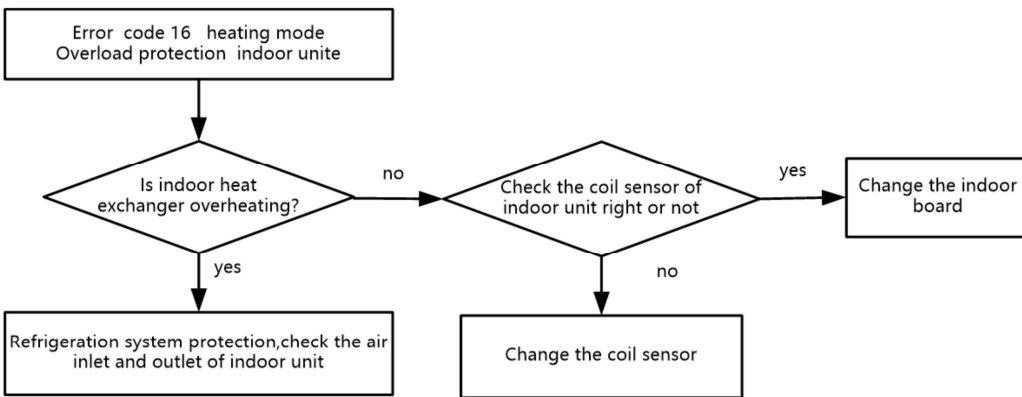
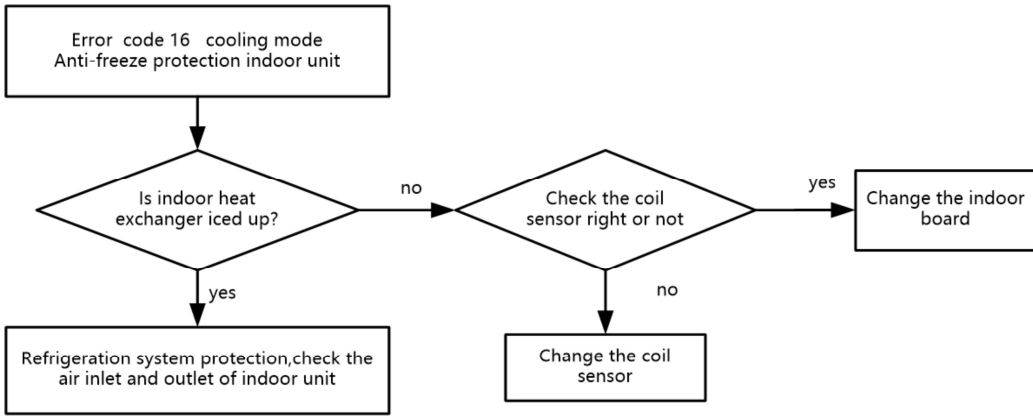

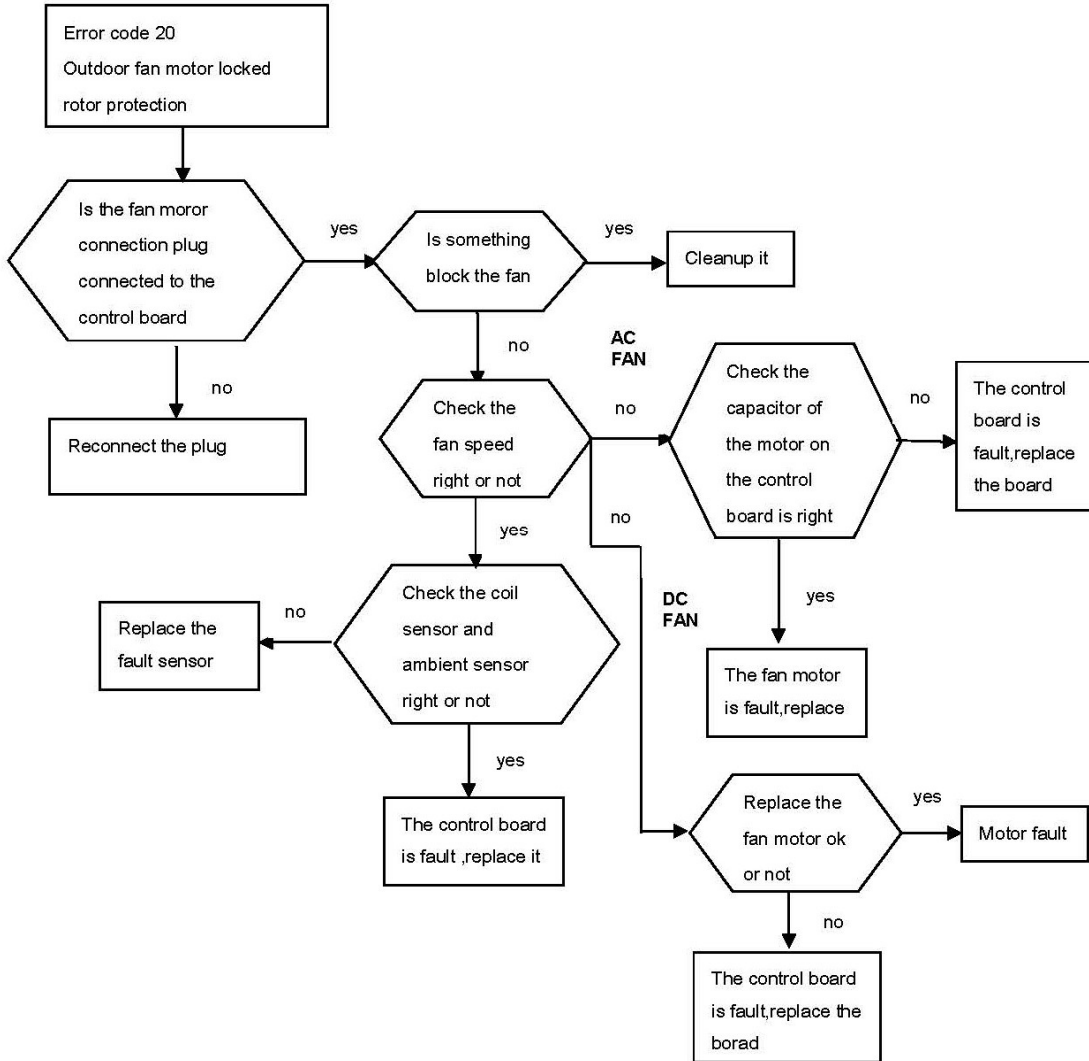

DC fan motor test point:



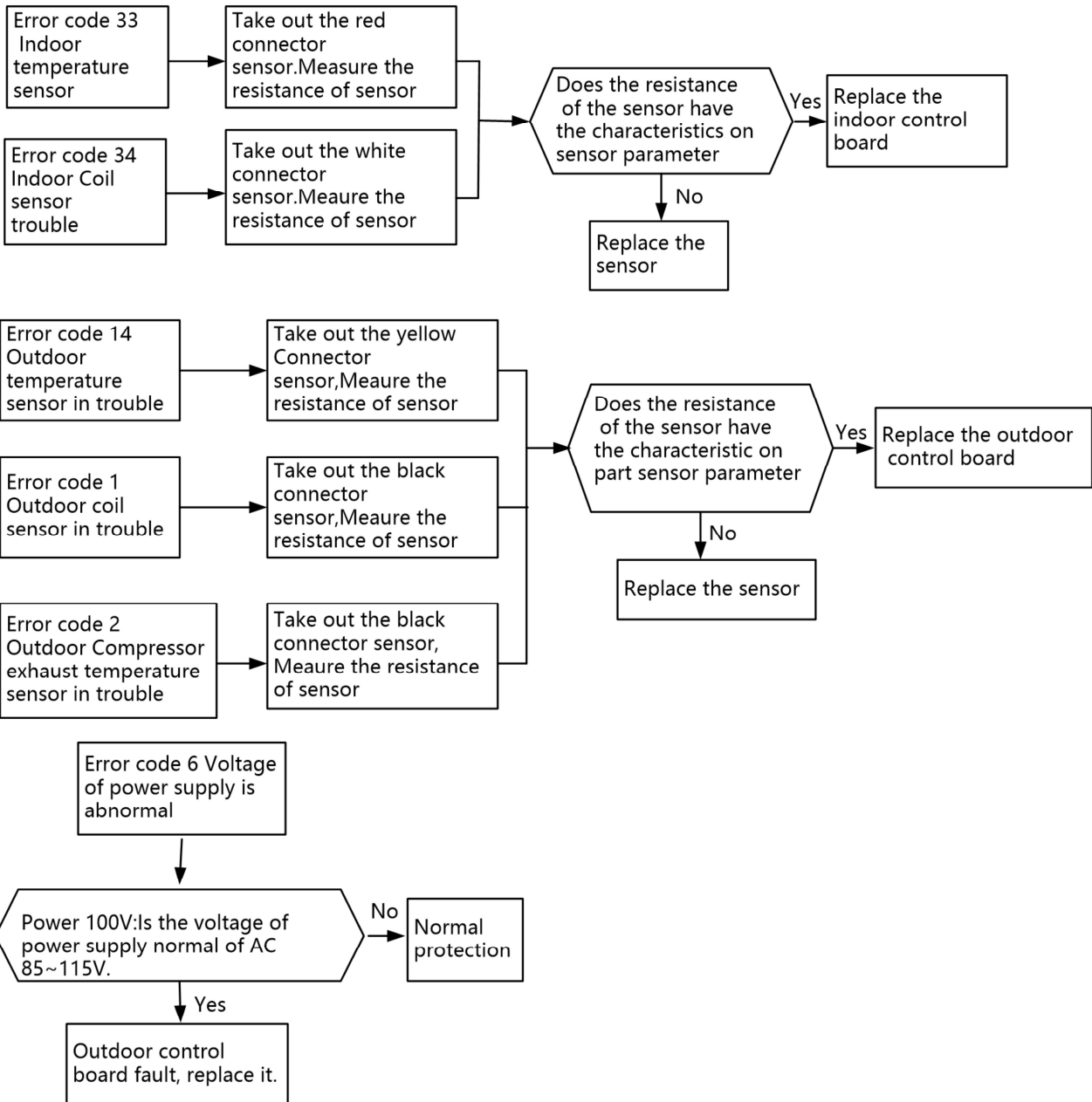

The Voltage protection values is different according to the model

AC voltage test point:

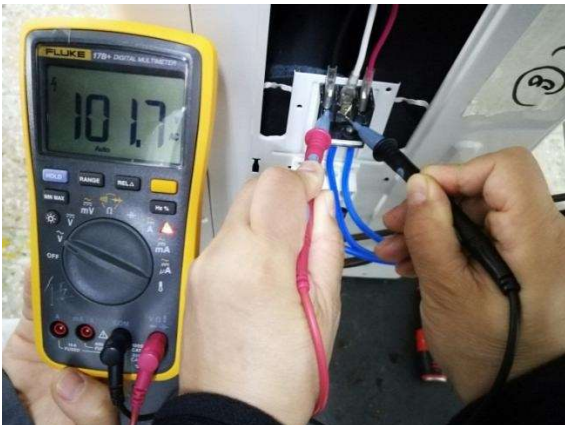

Sensor test point:



6.

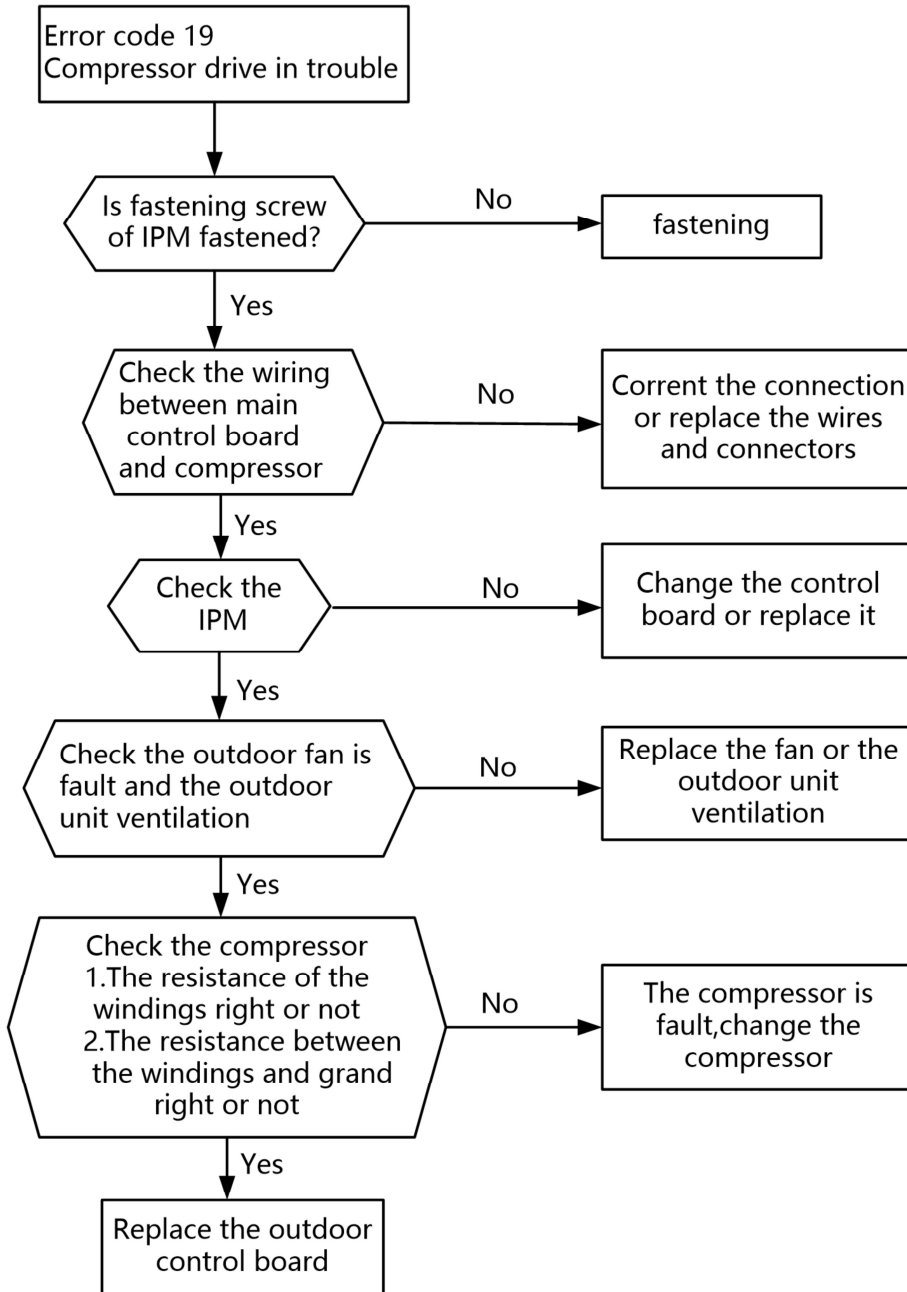

test point:

Check the screw of IPM fastening:

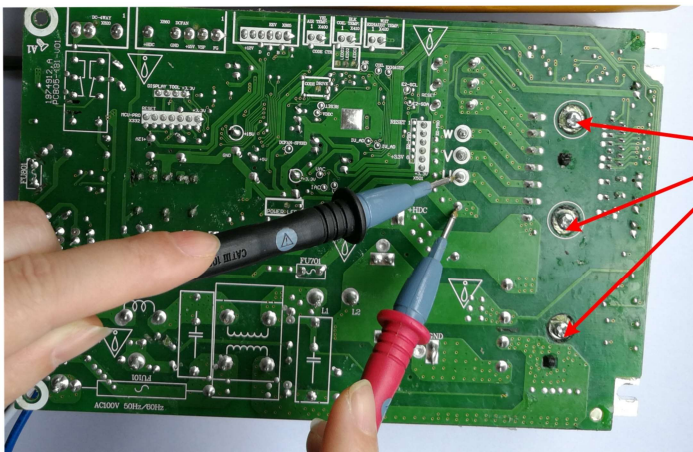

紧固IPM螺钉

test point:

Forward of IPM P-U/P-V/P-W test :

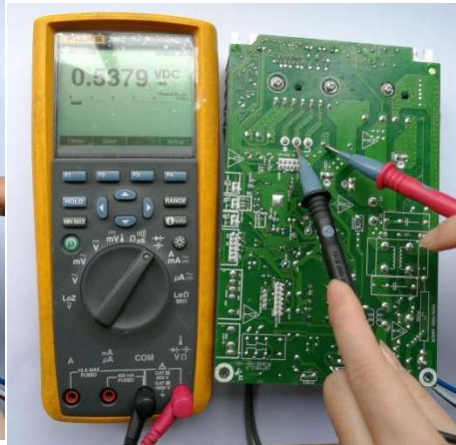

Reverse of IPM P-U/P-V/P-W test:

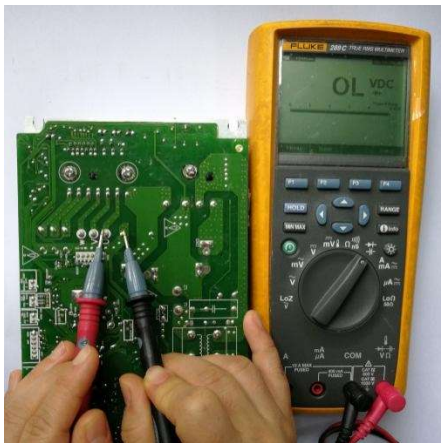

Forward of IPM N-U/N-V/N-W test :



Reverse of IPM N-U/N-V/N-W test :



test point:

The resistance of the compressor U-W\|V-W

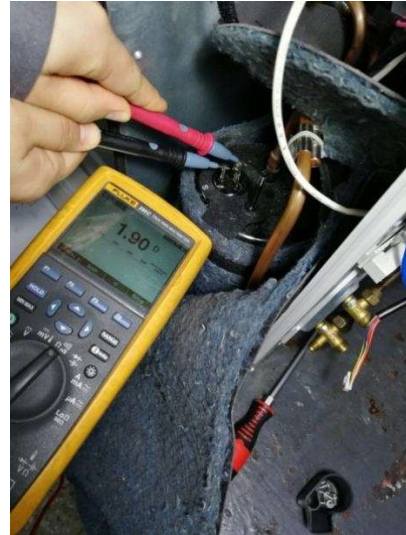
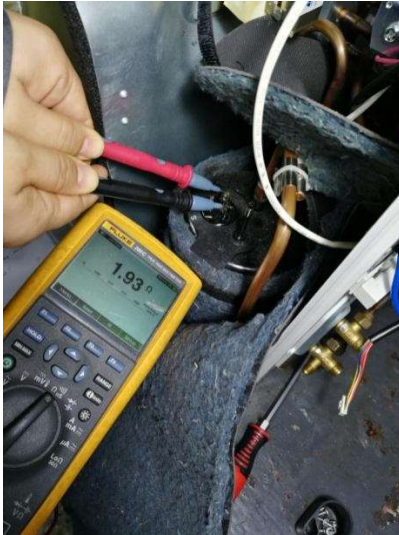

7.

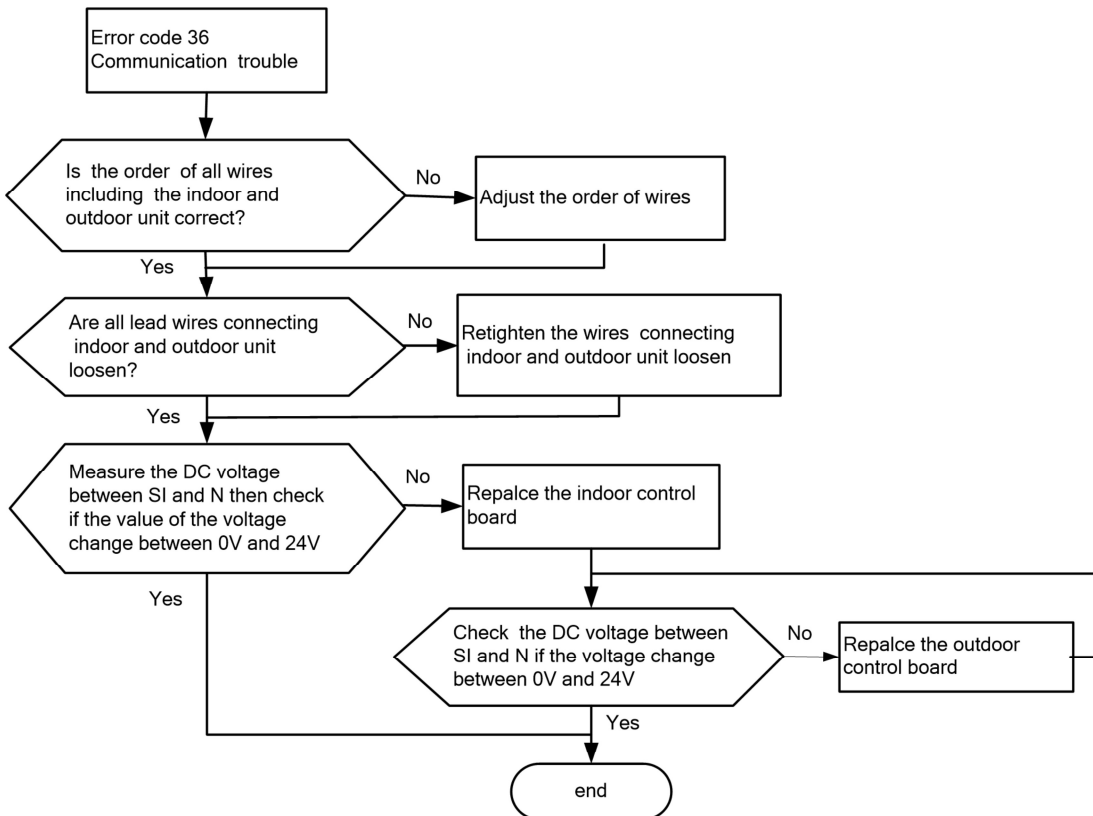

SI and N test point:

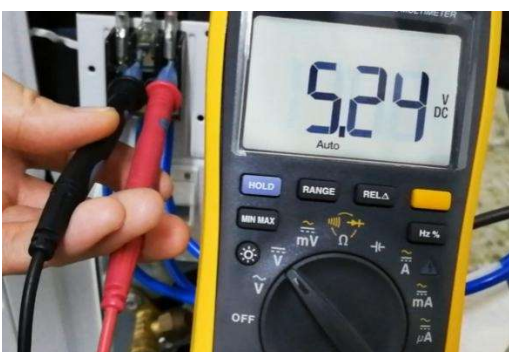



Hisense



EXCLUSIEF IMPORTEUR VAN HISENSE BENELUX

Carneool 400
3316 KC Dordrecht
Nederland

Tel.: +31 (0) 88 4 35 54 50
E-Mail: info@hs-cs.nl

Truibroek 94 | unit 11
3945 Ham
België

Tel.: +32 (0) 11 46 04 46
E-Mail: info@hs-cs.be