

Hisense

Switch Box Technical and Service Handbook

TCY32019004A

Hisense



Switch Box

Technical and Service Handbook

-Design-

-Installation-

-Service-

Models:
HCHS-N06XA
HCHS-N10XA
HCHM-N04XA
HCHM-N08XA
HCHM-N12XA
HCHM-N16XA

IMPORTANT:

*READ AND UNDERSTAND
THIS MANUAL CAREFULLY
BEFORE INSTALLING THIS
SWITCH BOX.
KEEP THIS MANUAL FOR
FUTURE REFERENCE.*

Hisense

Qingdao Hisense Hitachi Air-conditioning Systems Co.,Ltd.

Add: 218 Qianwangang Road, Economic & Technological Development Zone, Qingdao, P. R. China
Http: //www.hisense-vrf.com
E-mail: export@hisensehitachi.com

Specifications in this catalogue are subject to change without notice, in order that Hisense may bring the latest innovations to customers.

IMPORTANT NOTICE

- The applicable outdoor unit may be different depending on the product series. Improper combination will lead to malfunction and an alarm will be triggered. Be sure to confirm with the product catalogue before installation.
- Hisense pursues a policy of continuous improvement in the design and performance of products to meet regulatory requirements and industry standards. Therefore, Hisense reserves the right to revise specifications without notice.
- Hisense cannot anticipate every possible circumstance that might involve a potential hazard.
- This heat pump air conditioner is designed for standard air conditioning applications only. Do not use this heat pump air conditioner for other purposes, such as drying clothes, refrigerating foods, or for any other cooling or heating process.
- Do not install the unit outdoors. Do not install the unit in the following places. It may lead to a fire, deformation, corrosion or failure.
 - * Places where there is high level of oil mist (including machinery oil).
 - * Places where there is high alkalinity level (chlorine or bromine such as over hot tubs, etc.).
 - * Places where flammable gases or liquids may be used or generated.
 - * Places with a high concentration of salts, salty mists or sprays (such as over salt-water aquariums).
 - * Places with an atmosphere of high nuisance dust. Places with organic solvent atmospheres, such as painting and cleaning locations.
- Do not install a unit in the place where condensate water can leak onto the unit, otherwise electrical device failures may occur.
- Pay attention to the following points when the unit is installed in a hospital or other facilities where electromagnetic waves generate.
 - * Do not install the unit in places where electromagnetic waves radiate to the electrical box, wired controller cable or wired controller.
 - * Install the unit at least 3m (10 ft) away from electromagnetic waves or interferences such as a radio.
- The installer and system specialist shall secure against leakage according to local regulations or standards. This system has both high and low pressure refrigerant and, as such, comprises a pressurized system. Never loosen threaded joints while the system is under pressure and never open pressurized system parts.
- No part of this manual may be reproduced without written permission from Hisense.
- It is assumed that this heat pump air conditioner will be operated and serviced by English speaking people. If this is not the case, the distributor or dealer can provide or add safety, caution and operating signs in the native language.
- Should you have any questions, please contact your distributor.
- This manual describes the features of this heat pump air conditioner as well as for other models.
- This appliance is intended to be used by expert or trained users in shops, in light industry and on farms, or for commercial use by lay persons.

This manual should be considered as a permanent part of the air conditioning equipment and should remain with the air conditioning equipment.

CHECKING PRODUCT RECEIVED

- Upon receiving this product, inspect it for any shipping damage. Inspect all electrical connections. Connections must be clean and tight at the terminals. Claims for damage either apparent or concealed, should be filed immediately with the shipping company.
NOTE: Rough handling may dislocate internal components.
- Check the model number, electrical characteristics (power supply, voltage and frequency) and accessories to determine if they are correct with the ordering and shipping information, to ensure the correct unit has been shipped.
To minimize the possibility of damage after inspection, the units should be installed and reassembled as soon as possible.

The standard installation and general use of this unit is explained in this manual. Although common processes and procedures for installing units are presented in this manual, its use for installation of units otherwise indicated in this manual is not recommended. Please contact your local agent as the occasion arises. Our liability shall not cover defects arising from the alteration performed by a customer without our consent in a written form.

SAFETY SUMMARY

Signal Words

- Signal words are used to identify levels of hazard seriousness. Definitions for identifying hazard levels are provided below with their respective signal words.

 : Indicates a hazardous situation which, if not avoided, will result in death or serious injury.

 : Indicates a hazardous situation which, if not avoided, could result in death or serious injury.

 : Used with the safety alert symbol, indicates a hazardous situation which, if not avoided, could result in minor or moderate injury.

 : Used to address practices not related to personal injury.

NOTE : Useful information for operation or maintenance.

SAFETY SUMMARY

WARNING

- Do not use any sprays such as insecticide, lacquer, hair spray or other flammable gases within approximately 1.3m (4 ft) from the system.
- If the circuit breaker or fuse is frequently activated, stop the system and contact your service contractor.
- Check that the ground wiring is securely connected. If the unit is not correctly grounded, it may lead to an electric shock. Do not connect the ground wiring to gas piping, condensate piping, lighting conductor or ground wiring for telephones.
- Before performing any brazing work, check to ensure that there is no flammable material around. When using refrigerant, be sure to wear leather gloves to prevent from cold injury.
- Insulate electrical wiring, condensate piping, and electrical components from threats posed by burrowing animals and temperature extremes. Failure to do so can, over time, deteriorate system performance.
- Secure the cables. External forces on the terminals could lead to a fire.
- Tighten the flare nut with a torque wrench in the specified manner. Do not apply excessive force to the flare nut when tightening. Otherwise, the flare nut can crack and refrigerant leakage may occur.
- When maintaining, relocating or disposing of the unit, dismantle the refrigerant piping after the compressor stops.
- Highly dangerous electrical voltages are used in this system. Carefully refer to the wiring diagram and these instructions when wiring. Improper connections and inadequate grounding can cause serious injury or death.
- Perform all electrical work in strict accordance with this installation and maintenance manual and all relevant regulatory standards.
- Use specified cables between units.
- Be sure to install circuit breakers (ground fault interrupter, isolating switch, molded case circuit breaker and so on), with the specified capacity. Ensure that the wiring terminals are tightened securely to recommended torque specifications. If a circuit breaker or fuse is frequently activated, shut down the system and contact your service contractor.
- Clamp electrical wires securely with a cable clamp after all wiring is connected to the terminal block. In addition, run wires securely through the wiring access channel.
- When installing the power lines, do not apply tension to the cables. Secure the suspended cables at regular intervals, but not too tightly.
- After stopping operation, be sure to wait at least five minutes before turning off the main power switch. Otherwise, water leakage or electrical breakdown may result. Disconnect the power supply completely before attempting any maintenance for electrical parts. Check to ensure that no residual voltage is present after disconnecting the power supply.
- Insulate the refrigerant pipe connection to prevent condensation.
- Be sure to attach the cover so that it fits securely on the electrical box without any gaps. Secure the cover with screws.
- This appliance is not intended for use by persons (including children) with reduced physical, sensory or mental capabilities, or lack of experience and knowledge, unless they have been given supervision or instruction concerning use of the appliance by a person responsible for their safety.
- Children should be supervised to ensure that they do not play with the appliance.
- If the supply cord is damaged, it must be replaced by the manufacturer, its service agent or similarly qualified persons in order to avoid a hazard.

SAFETY SUMMARY

DANGER

- Do not perform installation work, refrigerant piping work, condensate pump, or condensate piping and electrical wiring connection without referring to the installation manual. If the instructions are not followed, it may result in a water leakage, electric shock or a fire.
- Use the specified non-flammable refrigerant (R410A) for the outdoor unit in the refrigerant cycle. Charge only R410A into the unit. Do not charge other materials into the unit such as hydrocarbon refrigerants (propane), oxygen, flammable gases (acetylene) or poisonous gases when installing, maintaining and moving the unit. These flammables are extremely dangerous and may cause an explosion, a fire, or injury. As originally manufactured, this unit contains refrigerant installed by Hisense. Hisense uses only refrigerants that have been approved for use in the unit's intended country or market. Hisense distributors similarly are only authorized to provide refrigerants that have been approved for use in the countries or markets they serve. The refrigerant used in this unit is identified on the unit's faceplate and/or in the associated manuals. Any additions of refrigerant into this unit must comply with the country's requirements with regard to refrigerant use and should be obtained from Hisense distributors. Use of unapproved refrigerant substitutes will void the warranties and can cause injury or death.
- Do not pour water into the indoor or outdoor unit. These units are equipped with electrical parts. Exposure to water may cause a serious electric shock.
- Users are not allowed to open the service cover or access panel for the indoor or outdoor units by themselves. For professional technicians, please turn OFF the main power supply before operating.
- Do not touch or adjust safety devices inside the indoor unit or outdoor units. If these devices are touched or readjusted, it may cause a serious accident.
- Carefully check for escaping refrigerant gas. If there is significant leakage, it can cause difficulty in breathing. Turn OFF the main switch, and contact your service contractor if refrigerant leakage occurs.
- Make sure that the refrigerant leakage test is performed.
Refrigerant (fluorocarbon) for this unit is incombustible, non-toxic and odorless.
However if the refrigerant is leaked and comes in contact with fire, toxic gas will generate.
Because fluorocarbon is heavier than air, the floor surface will be filled with it, which could cause suffocation.
- The installer and system specialist shall secure against refrigerant leakage according to local regulations or standards.
- Use a Earth Leakage Breaker (ELB).
In the event of fault, there is danger of an electric shock or a fire if it is not used.

⚠ CAUTION

- Do not step on the unit.
- Do not put any foreign matters on the unit or inside the unit.
- Provide a strong and correct foundation so that:
 - The outdoor unit is not on an incline.
 - Abnormal sound does not occur.
 - The outdoor unit will not fall down due to a strong wind or earthquake.
 - A warning to assure that partial units shall only be connected to an appliance suitable for the same refrigerant.
 - This unit is a partial unit air conditioner, complying with partial unit requirements of this International Standard, and must only be connected to other units that have been confirmed as complying to corresponding partial unit requirements of this International Standard.

NOTICE

- Be careful that moisture, dust, or variant refrigerant compounds not enter the refrigerant system during installation work. Foreign matter could damage internal components or cause blockages.
- Do not install the indoor unit, outdoor unit, wired controller and cable within approximately 3m (10 ft) of strong electromagnetic wave radiators such as medical equipment.
- After a long shutdown, apply power to the outdoor unit(s) at least 12 hours prior to operation of the system for preheating of the compressor oil.
- The A-weighted emission sound pressure level is below 70 dB(A);

NOTE

- It is recommended that the room is ventilated every three to four hours.
- The heating capacity of the heat pump unit is decreased according to the outdoor air temperature. Therefore, it is recommended that auxiliary heating equipment be used in the field when the unit is installed in a low temperature region.

IMPORTANT NOTICE



Correct Disposal of this product

This marking indicates that this product should not be disposed with other household wastes. To prevent possible harm to the environment or human health from uncontrolled waste disposal, recycle it responsibly to promote the sustainable reuse of material resources. To return your used device, please use the return and collection systems or contact the retailer where the product was purchased. They can take this product for environmental safe recycling.

TABLE OF CONTENTS

1. General Information.....	1
1.1 Safety Summary	1
1.2 Unit Nomenclature.....	1
1.3 Line-up	1
2. General Data.....	2
3. Dimensional Data.....	3
4. Control system.....	6
4.1 Refrigeration Cycle.....	6
4.2 Electrical wiring diagrams.....	9
4.3 Electrical Wiring and Settings.....	15
4.3.1 Switch Box HCHS-N(06/10)XA.....	15
4.3.2 Switch Box HCHM-N(04~16)XA.....	17
5. Sound Data.....	21
6. Transportation and Handling.....	23
6.1 Transportation.....	23
6.2 Handling of Switch Box.....	23
6.3 Combination of Switch Box and Indoor Unit.....	23
7. Installation.....	25
7.1 Factory-Supplied Accessories.....	25
7.2 Initial Check.....	27
7.3 Suspension Bolts.....	29
7.4 Installation.....	31
7.4.1 Changing the Location of the Electrical Box.....	31
7.4.2 Marking of the Positions of the Suspension Bolts and Wiring Connections.....	32
8. Refrigerant Piping Work.....	33
9. Test Run.....	45
10. Alarm code.....	46
11. Servicing.....	49
11.1 Removing Components for Switch Over Box.....	49
11.1.1 Removing Service Cover for Electrical Box and Electronic Expansion Valve.....	49
11.1.2 Removing Electrical Components.....	51
11.1.3 Removing Electric Expansion Valve Coil.....	54
12. Specifications for MVD and MVS.....	57
13. Safety and Control Device Setting.....	58

1. General Information

1.1 Safety Summary

! WARNING

- Do not perform installation work, refrigerant piping work or electrical wiring connection without referring to our installation manual.
- Check that the ground wire is securely connected.
- Connect a fuse of specified capacity.

! CAUTION

Do not install the Switch Box and cable within approximately 3m (10 ft) from strong electromagnetic wave radiators such as medical equipment.

1.2 Unit Nomenclature

Single Branch Type

Multiple Branch Type
4 Ports

8 Ports

12 Ports

16 Ports



1.3 Line-up

Type	Capacity				Model
	HP	kBtu/h	kW	RT	
Switch Box	6	54	16	4.77	HCHS-N06XA
	10	96	28	8	HCHS-N10XA
	16	154	44.8	12.73	HCHM-N04XA
	30	290	85	24.14	HCHM-N08XA
	30	290	85	24.14	HCHM-N12XA
	30	290	85	24.14	HCHM-N16XA

2. General Data

Type			Single Branch		Multiple Branch			
Model			HCHS-N06XA	HCHS-N10XA	HCHM-N04XA	HCHM-N08XA	HCHM-N12XA	HCHM-N16XA
Power Supply			220-240V ~ 50Hz ; 208-230V ~ 60Hz					
Power Consumption		W	5.6	5.6	11.2	22.4	33.6	44.8
Number of Ports (for Indoor Unit)			1	1	4	8	12	16
Single Unit Per Port	Maximum Total Capacity of All Connected Indoor Units	kBtu/h (kW) (RT)	≤ 54 (16) (4.77)	≤ 96 (28) (8)	≤ 154 (44.8) (12.73)	≤ 290 (85) (24.14)	≤ 290 (85) (24.14)	≤ 290 (85) (24.14)
	Maximum Total Capacity of Connected Indoor Units Per Port	kBtu/h (kW) (RT)	-	-	≤ 54(16)(4.77) ¹	≤ 54(16)(4.77) ¹	≤ 54(16)(4.77) ¹	≤ 54(16)(4.77) ¹
Multiple Units Per Port	Maximum Number of Connected Indoor Units Per Port	-	8	8	8	8	6	6
	Maximum Total Capacity of All Connected Indoor Units	kBtu/h (kW) (RT)	≤ 54 (16) (4.77)	≤ 96 (28) (8)	≤ 154 (44.8) (12.73)	≤ 290 (85) (24.14)	≤ 290 (85) (24.14)	≤ 290 (85) (24.14)
	Maximum Total Capacity of Connected Indoor Units Per Port	kBtu/h (kW) (RT)	-	-	≤ 54 (16) (4.77)	≤ 54 (16) (4.77)	≤ 54 (16) (4.77)	≤ 54 (16) (4.77)
Outer Dimensions	Height	mm	191	191	260	260	260	260
	Width	mm	301	301	303	543	783	1023
	Depth	mm	214	214	352	352	352	352
Net Weight		kg(lbs)	6.3(13.9)	6.4(14.1)	14.1(31.1)	25.2(55.6)	35.5(78.3)	46.7(103.0)
Refrigerant		-	R410A					
Running current		A	0.1	0.1	0.2	0.4	0.6	0.8
Recommended Fuse/Breaker Size		A	15	15	15	15	15	15
Maximum Fuse Size		A	15	15	15	15	15	15
Refrigerant Piping (from Outdoor Unit)	Gas Line (High/Low Pressure)	mm	15.88	15.88	22.2	22.2	25.4 ²	28.6
	Gas Line (Low Pressure)	mm	19.05	19.05	25.4 ²	28.6	28.6	31.75
	Liquid Line	mm	-	-	12.7	12.7	15.88	19.05
Refrigerant Piping (from Indoor Unit)	Gas Line	mm	15.88	19.05	15.88	15.88	15.88	15.88
	Liquid Line	mm	-	-	9.53	9.53	9.53	9.53

1. Make sure to increase the pipe connection size by using the appropriate accessory pipe.
2. Apply reducer (accessory pipe) for changing the pipe size to $\phi 22.2\text{mm}$ for field pipe connection.

3. Dimensional Data

HCHS-N06XA

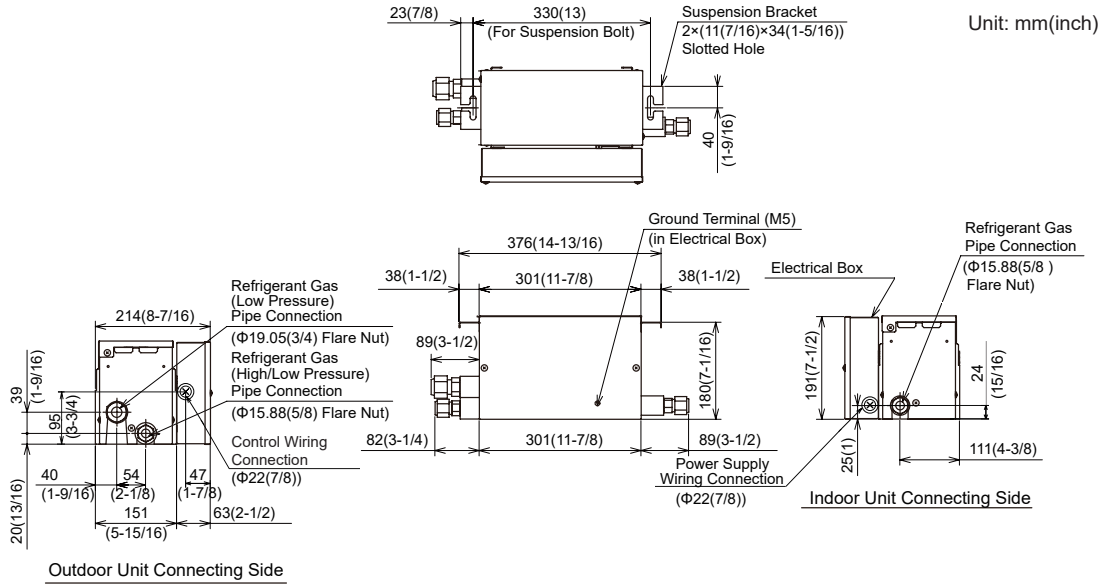

Power Supply	220-240V ~ 50Hz ; 208-230V ~ 60Hz	Net Weight	6.3kg(13.9lbs)
Power consumption	5.6W	Number of connectable indoor units	1 to 8
Refrigerant	R410A	Indoor unit total capacity	6.0HP(54kBtu/h,16kW,4.77RT) or less

HCHS-N10XA

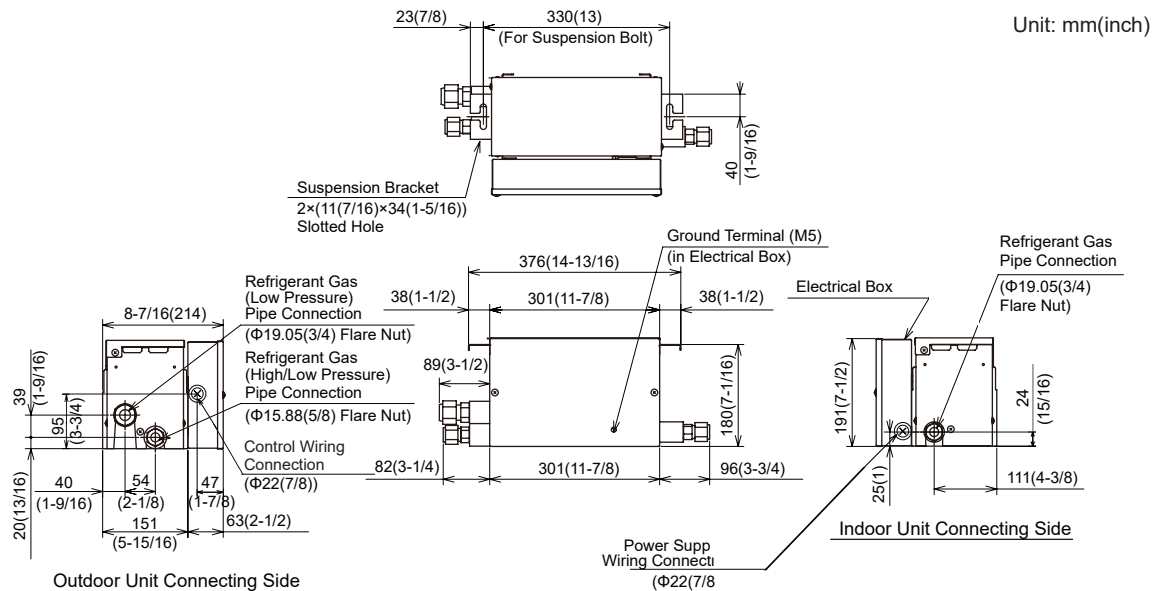

Power Supply	220-240V ~ 50Hz ; 208-230V ~ 60Hz	Net Weight	6.4kg(14.1lbs)
Power consumption	5.6W	Number of connectable indoor units	1 to 8
Refrigerant	R410A	Indoor unit total capacity	10HP(96kBtu/h,28kW,8RT) or less

HCHM-N04XA

Unit: mm (inch)

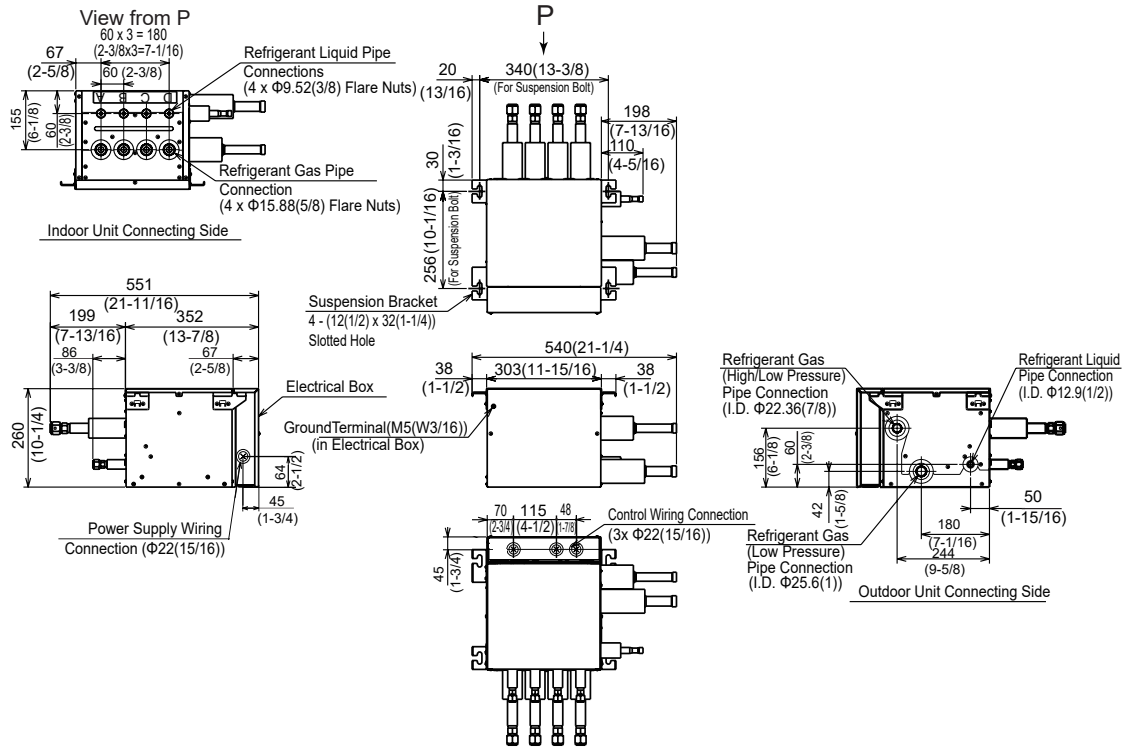

Model	HCHM-N04XA	Net Weight	14.1kg(31.1lbs)
Power Supply	220-240V ~ 50Hz ; 208-230V ~ 60Hz	Number of connectable indoor units per branch	1 to 8
Input (W)	11.2	Connectable indoor unit total capacity	16.0HP(154kBtu/h,44.8kW,12.73RT) or less
Refrigerant	R410A	Connectable indoor unit total capacity per branch	6.0HP(54kBtu/h,16kW,4.77RT) or less

HCHM-N08XA

Unit: mm (inch)

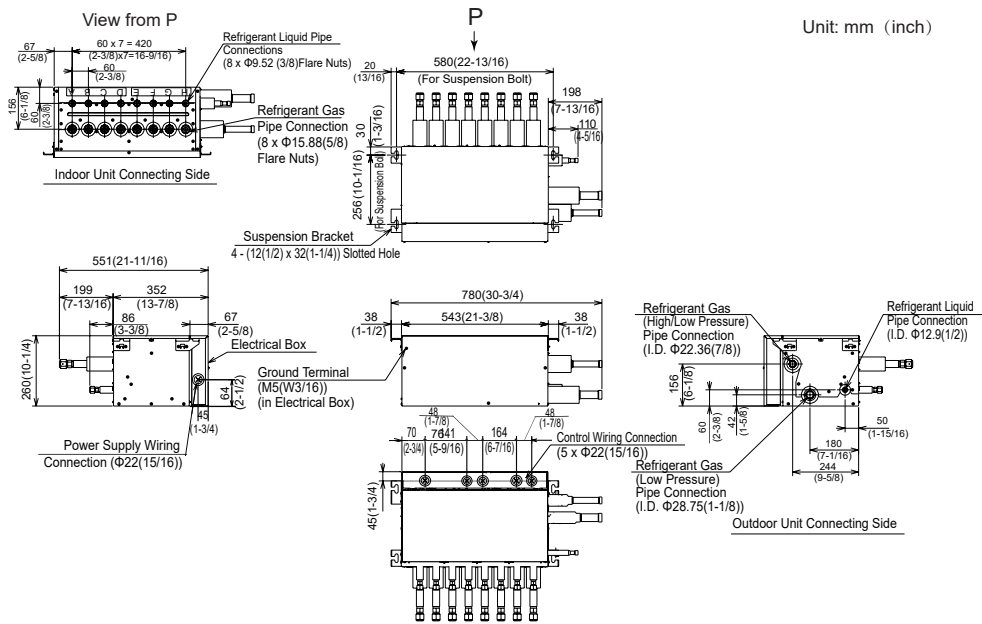

Model	HCHM-N08XA	Net Weight	25.2kg(55.6lbs)
Power Supply	220-240V ~ 50Hz ; 208-230V ~ 60Hz	Number of connectable indoor units per branch	1 to 8
Input (W)	22.4	Connectable indoor unit total capacity	30.0HP(290kBtu/h,85kW,24.14RT) or less
Refrigerant	R410A	Connectable indoor unit total capacity per branch	6.0HP(54kBtu/h,16kW,4.77RT) or less

HCHM-N12XA

Unit: mm (inch)

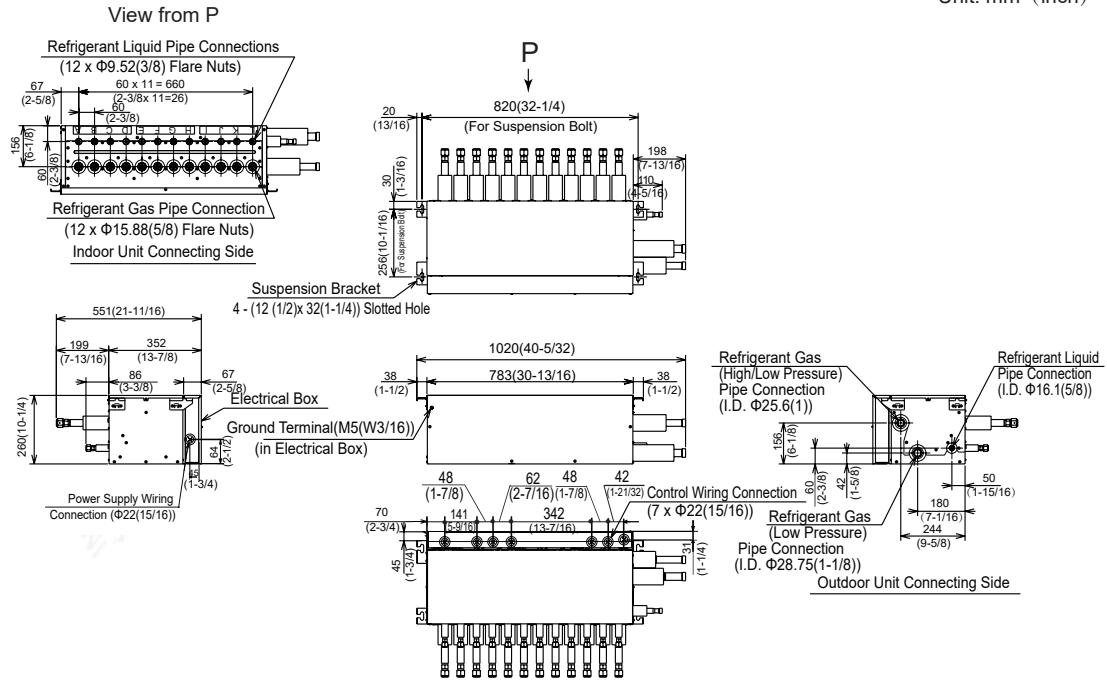

Model	HCHM-N12XA	Net Weight	35.5kg(78.3lbs)
Power Supply	220-240V ~ 50Hz ; 208-230V ~ 60Hz	Number of connectable indoor units per branch	1 to 6
Input (W)	33.6	Connectable indoor unit total capacity	30.0HP(290kBtu/h,85kW,24.14RT) or less
Refrigerant	R410A	Connectable indoor unit total capacity per branch	6.0HP(54kBtu/h,16kW,4.77RT) or less

HCHM-N16XA

Unit: mm (inch)

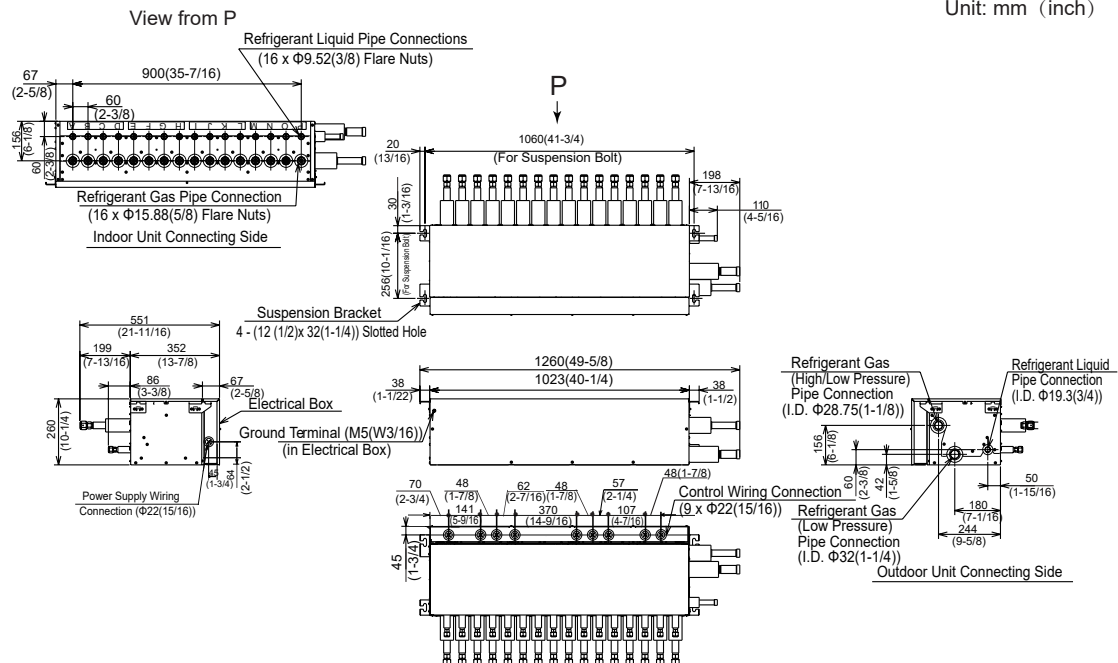

Model	HCHM-N16XA	Net Weight	46.7kg(103.0lbs)
Power Supply	220-240V ~ 50Hz ; 208-230V ~ 60Hz	Number of connectable indoor units per branch	1 to 6
Input (W)	44.8	Connectable indoor unit total capacity	30.0HP(290kBtu/h,85kW,24.14RT) or less
Refrigerant	R410A	Connectable indoor unit total capacity per branch	6.0HP(54kBtu/h,16kW,4.77RT) or less

4. Control system

4.1 Refrigeration Cycle

HCHS-N(06/10)XA

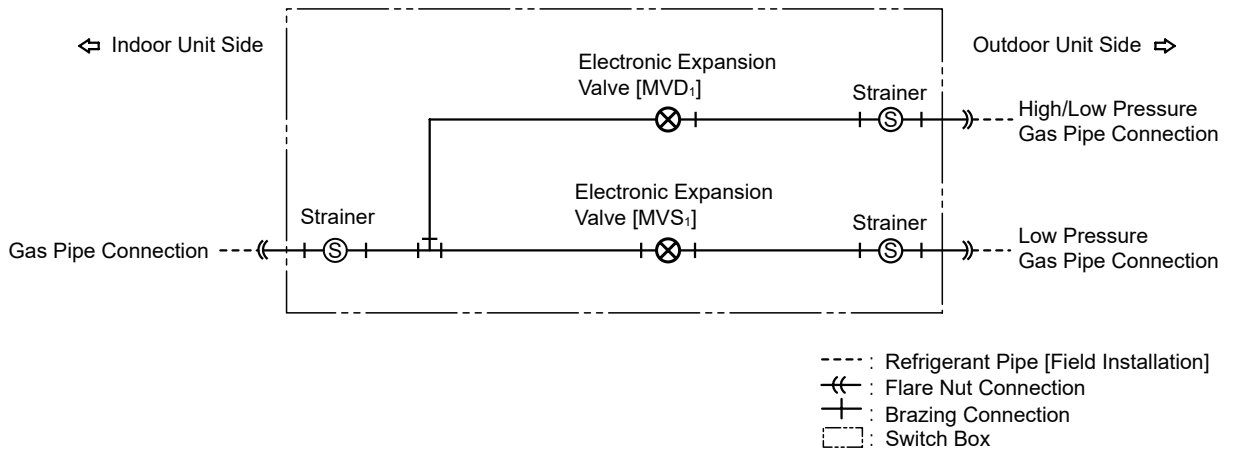

HCHM-N04XA

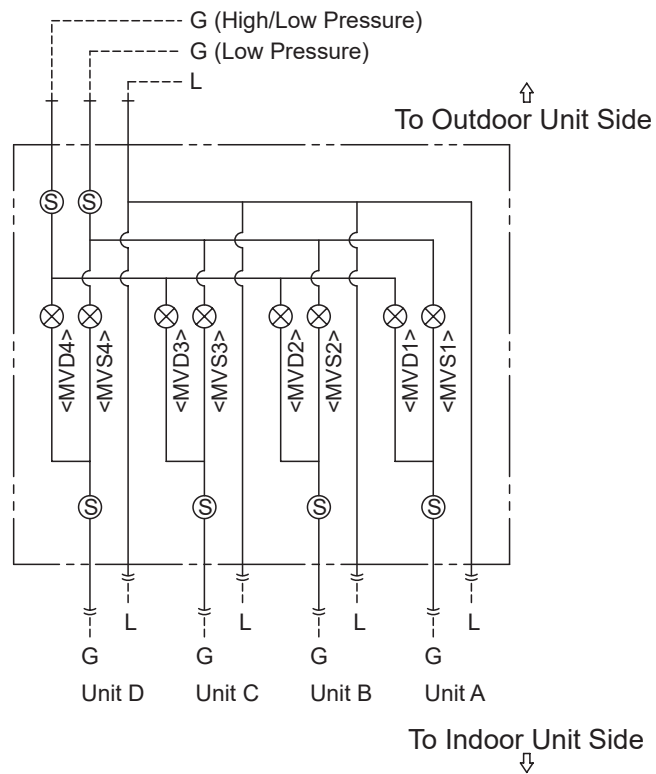

Mark	Part Name
⊗	Electronic Expansion Valve
⊙	Strainer

HCHM-N08XA

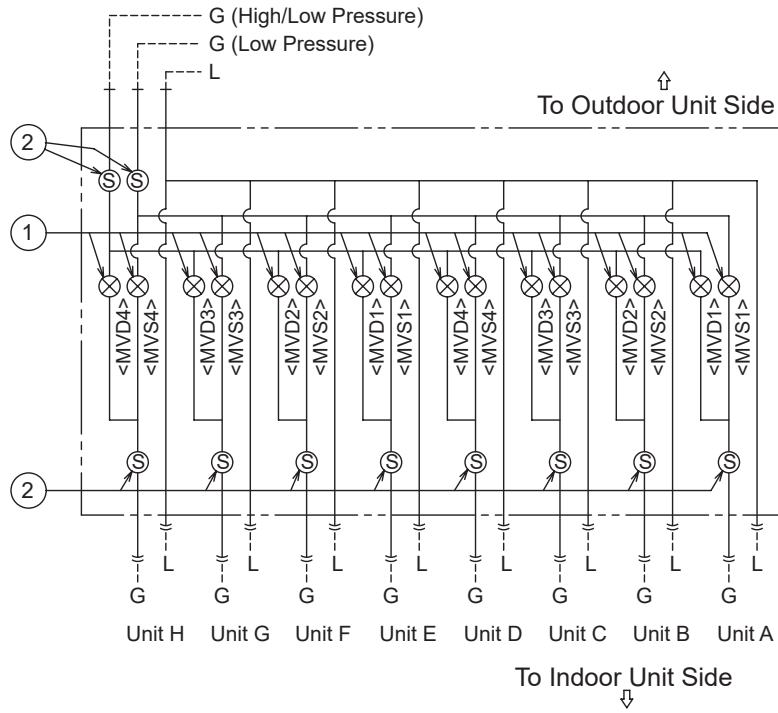

HCHM-N12XA

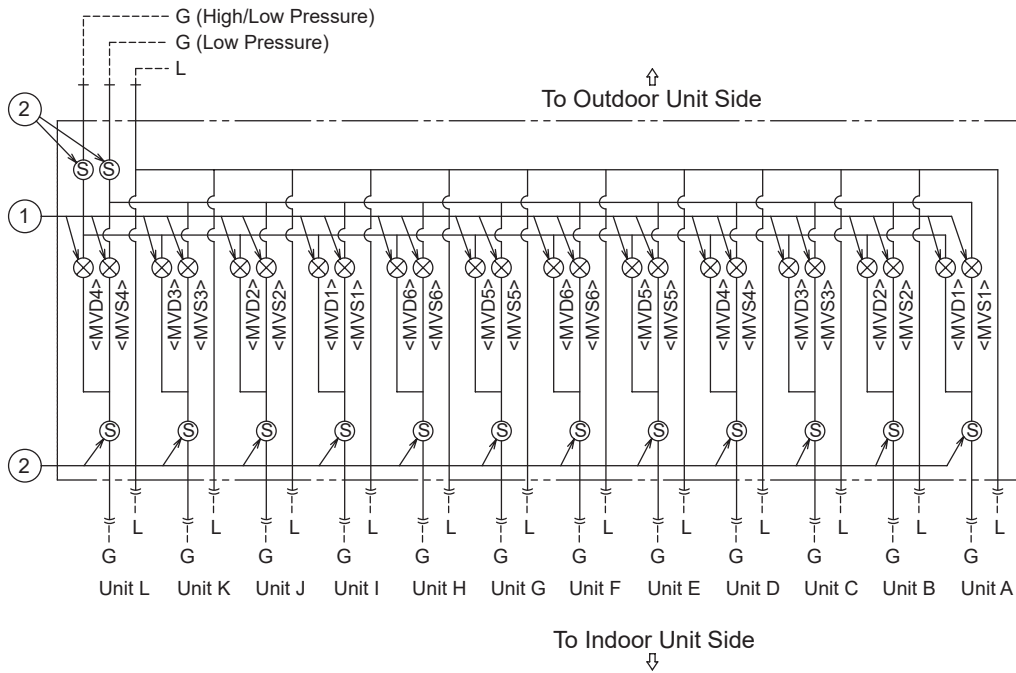

Mark	Part Name
①	Electronic Expansion Valve
②	Strainer

- G : Refrigerant Gas Pipe Connection
- L : Refrigerant Liquid Pipe Connection
- - - : Field Refrigerant Piping
- ⊥ : Flare Connection
- ⊕ : Brazing Connection
- [] : Switch Box

HCHM-N16XA

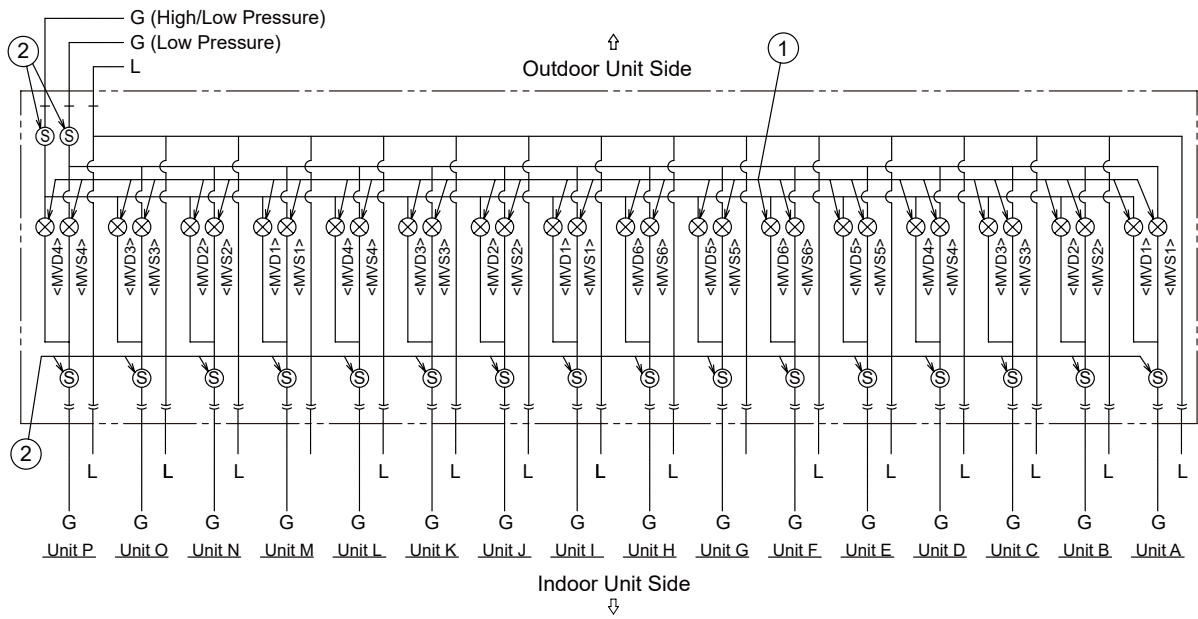

Mark	Part Name
①	Electronic Expansion Valve
②	Strainer

- G : Refrigerant Gas Pipe Connection
- L : Refrigerant Liquid Pipe Connection
- : Field Refrigerant Piping
- ⊥ : Flare Connection
- ⊕ : Brazing Connection
- ⊠ : Switch Box

4.2 Electrical Wiring Diagrams

HCHS-N06XA, HCHS-N10XA

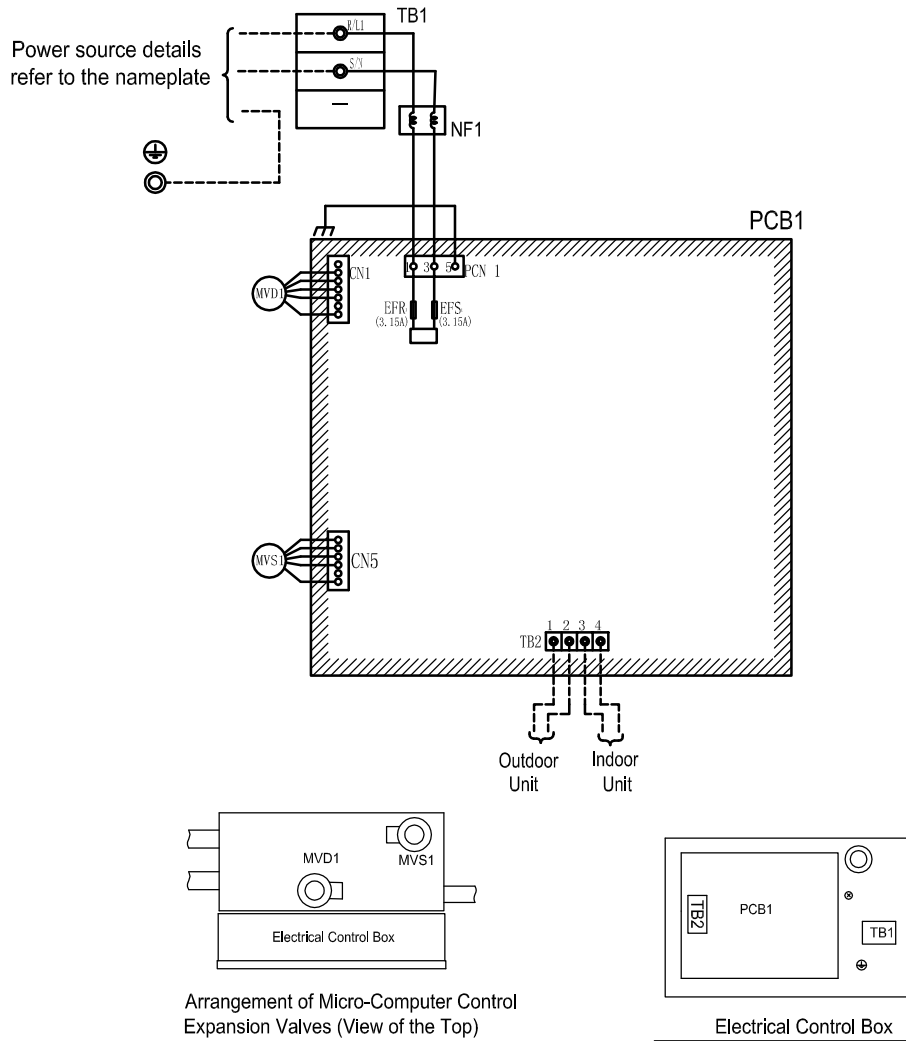

Mark	Torque to tighten the terminal	Screw Size
TB1	1.0~1.3(N·m)	M4
TB2	0.7~1.1(N·m)	M3.5

Mark	Name	Remark
PCB1	Printed Circuit Board	
TB1	Terminal Block	Power Supply
TB2	Terminal Block	Operating Line
MVD1 MVS1	Micro-Computer Control Expansion Valve	
NF1	Noise Filter	
EFR EFS	Fuse	

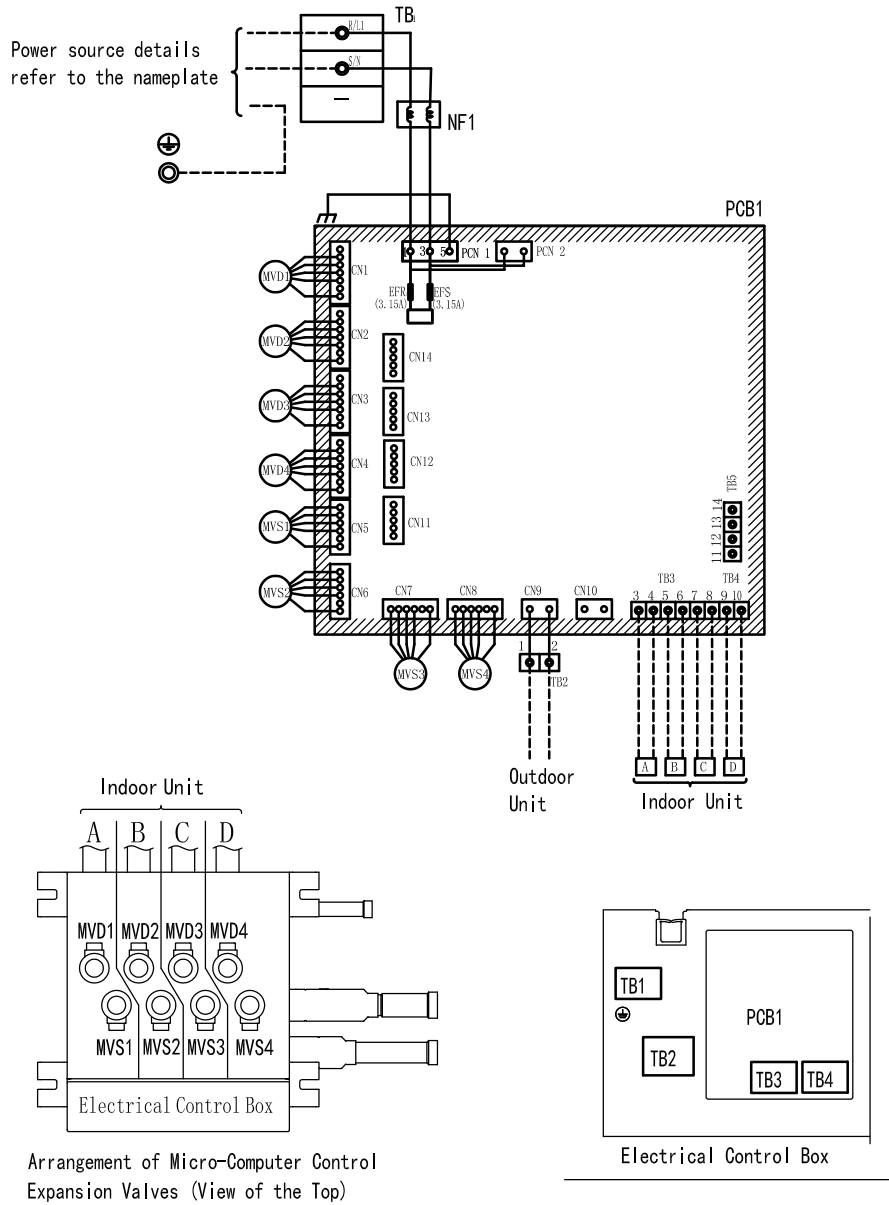

Mark	Torque to tighten the terminal	Screw Size
TB1	1.0~1.3 (N·m)	M4
TB2	1.0~1.3 (N·m)	
TB3,4	0.7~1.1 (N·m)	M3.5

Indoor Unit	Mark		
Indoor Unit A	PCB1	TB3-3	MVD1
		TB3-4	MVS1
Indoor Unit B		TB3-5	MVD2
		TB3-6	MVS2
Indoor Unit C	TB4-7	MVD3	
	TB4-8	MVS3	
Indoor Unit D	TB4-9	MVD4	
	TB4-10	MVS4	

Mark	Name	Remark
PCB1	Printed Circuit Board	
TB1	Terminal Block	Power Supply
TB2	Terminal Block	Operating Line[Outdoor Unit]
TB3,4	Terminal Block	Operating Line[Indoor Unit]
MVD1~4 MVS1~4	Micro-Computer Control Expansion Valve	
NF1	Noise Filter	
EFR, EFS _i	Fuse	

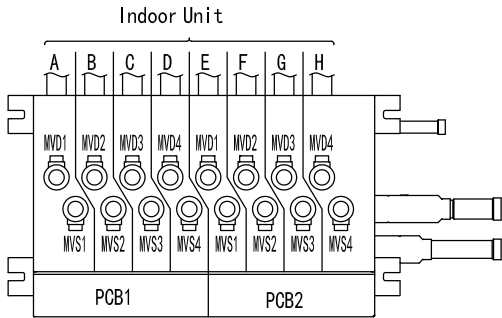
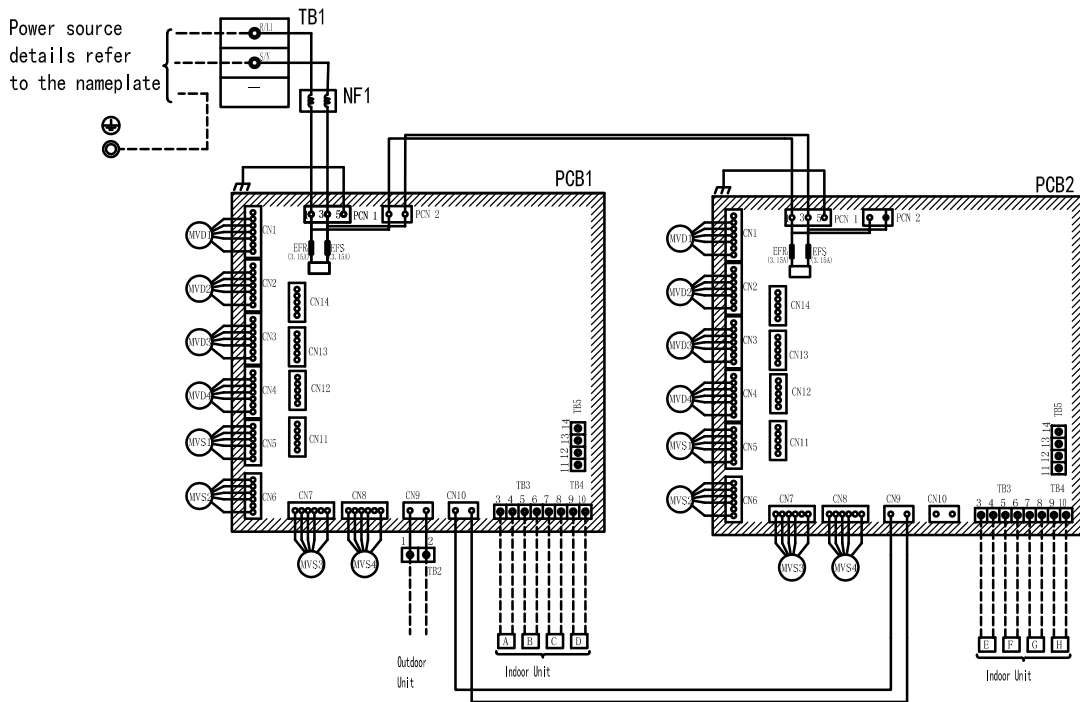

Arrangement of Micro-Computer Control Expansion Valves (View of the Top)

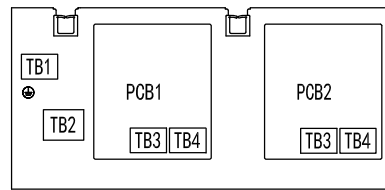

Electrical Control Box

Mark	Torque to tighten the terminal	Screw Size
TB1	1.0~1.3 (N·m)	M4
TB2	1.0~1.3 (N·m)	
TB3,4	0.7~1.1 (N·m)	M3.5

Mark	Name	Remark
PCB1, 2	Printed Circuit Board	
TB1	Terminal Block	Power Supply
TB2	Terminal Block	Operating Line[Outdoor Unit]
TB3,4	Terminal Block	Operating Line[Indoor Unit]
MVD1~4 MVS1~4	Micro-Computer Control Expansion Valve	
NF1	Noise Filter	
EFR, EFS _i	Fuse	

Indoor Unit	Mark		
Indoor Unit A	PCB1	TB3-3	MVD1
		TB3-4	MVS1
		TB3-5	MVD2
		TB3-6	MVS2
Indoor Unit B	PCB1	TB4-7	MVD3
		TB4-8	MVS3
Indoor Unit C	PCB1	TB4-9	MVD4
		TB4-10	MVS4
Indoor Unit D	PCB2	TB3-3	MVD1
		TB3-4	MVS1
Indoor Unit E	PCB2	TB3-5	MVD2
		TB3-6	MVS2
Indoor Unit F	PCB2	TB4-7	MVD3
		TB4-8	MVS3
Indoor Unit G	PCB2	TB4-9	MVD4
		TB4-10	MVS4
Indoor Unit H	PCB2	TB4-9	MVD4
		TB4-10	MVS4

HCHM-N12XA

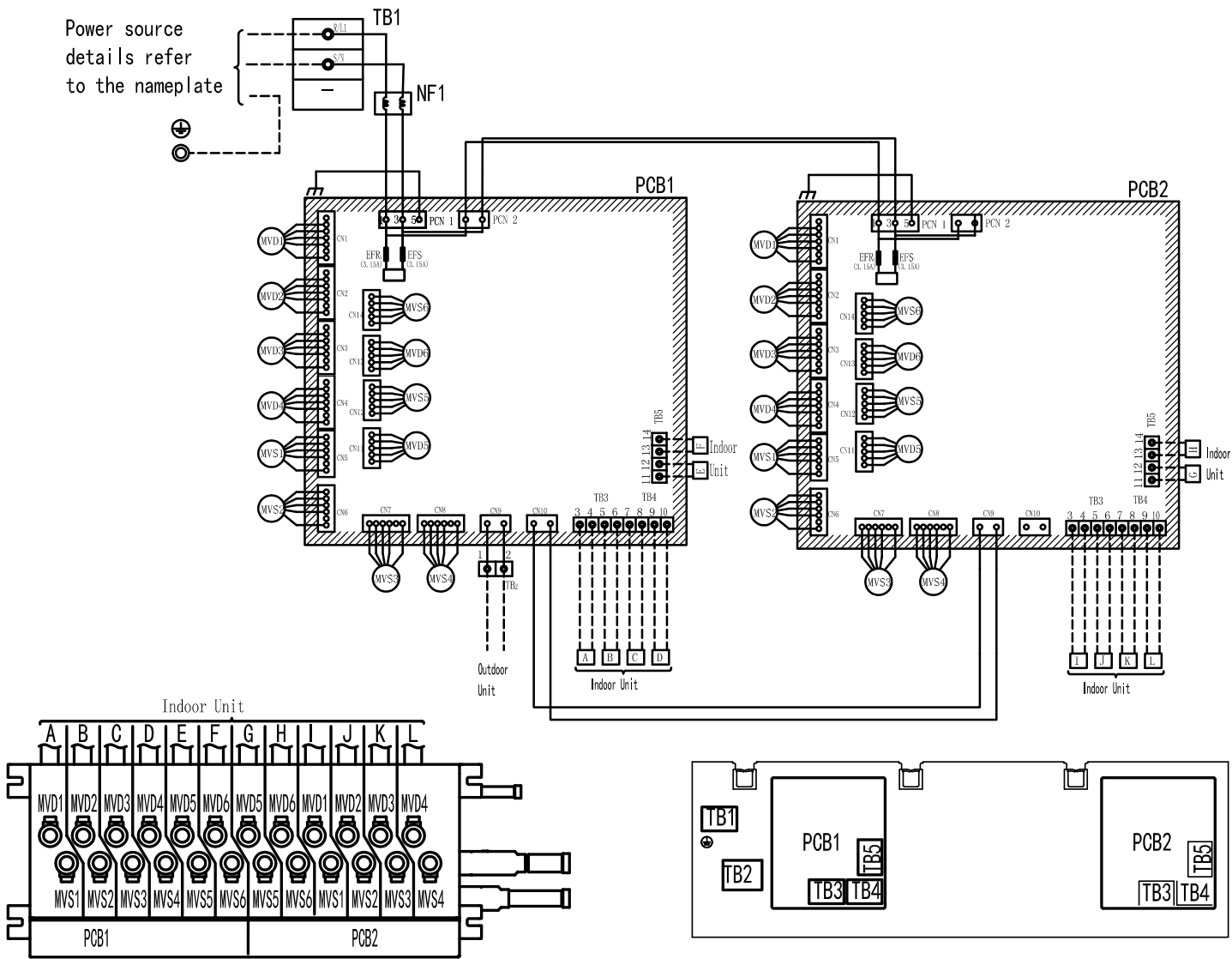

Arrangement of Micro-Computer Control Expansion Valves (View of the Top)

Electrical Control Box

Mark	Name	Remark
PCB1, 2	Printed Circuit Board	
TB1	Terminal Block	Power Supply
TB2	Terminal Block	Operating Line[Outdoor Unit]
TB3, 4, 5	Terminal Block	Operating Line[Indoor Unit]
MVD1~6 MVS1~6	Micro-Computer Control Expansion Valve	
NF1	Noise Filter	
EFR, EFS	Fuse	

Mark	Torque to tighten the terminal	Screw Size
TB1	1.0~1.3(N·m)	M4
TB2	1.0~1.3(N·m)	
TB3,4,5	0.7~1.1(N·m)	M3.5

Indoor Unit	Mark		
Indoor Unit A	PCB1	TB3-3	MVD1
Indoor Unit B		TB3-4	MVS1
Indoor Unit C		TB3-5	MVD2
Indoor Unit D		TB3-6	MVS2
Indoor Unit E	PCB2	TB4-7	MVD3
Indoor Unit F		TB4-8	MVS3
Indoor Unit G		TB4-9	MVD4
Indoor Unit H		TB4-10	MVS4
Indoor Unit I	PCB1	TB5-11	MVD5
Indoor Unit J		TB5-12	MVS5
Indoor Unit K		TB5-13	MVD6
Indoor Unit L		TB5-14	MVS6
Indoor Unit A	PCB2	TB3-3	MVD1
Indoor Unit B		TB3-4	MVS1
Indoor Unit C		TB3-5	MVD2
Indoor Unit D		TB3-6	MVS2
Indoor Unit E	PCB1	TB4-7	MVD3
Indoor Unit F		TB4-8	MVS3
Indoor Unit G		TB4-9	MVD4
Indoor Unit H		TB4-10	MVS4

Power source details refer to the nameplate

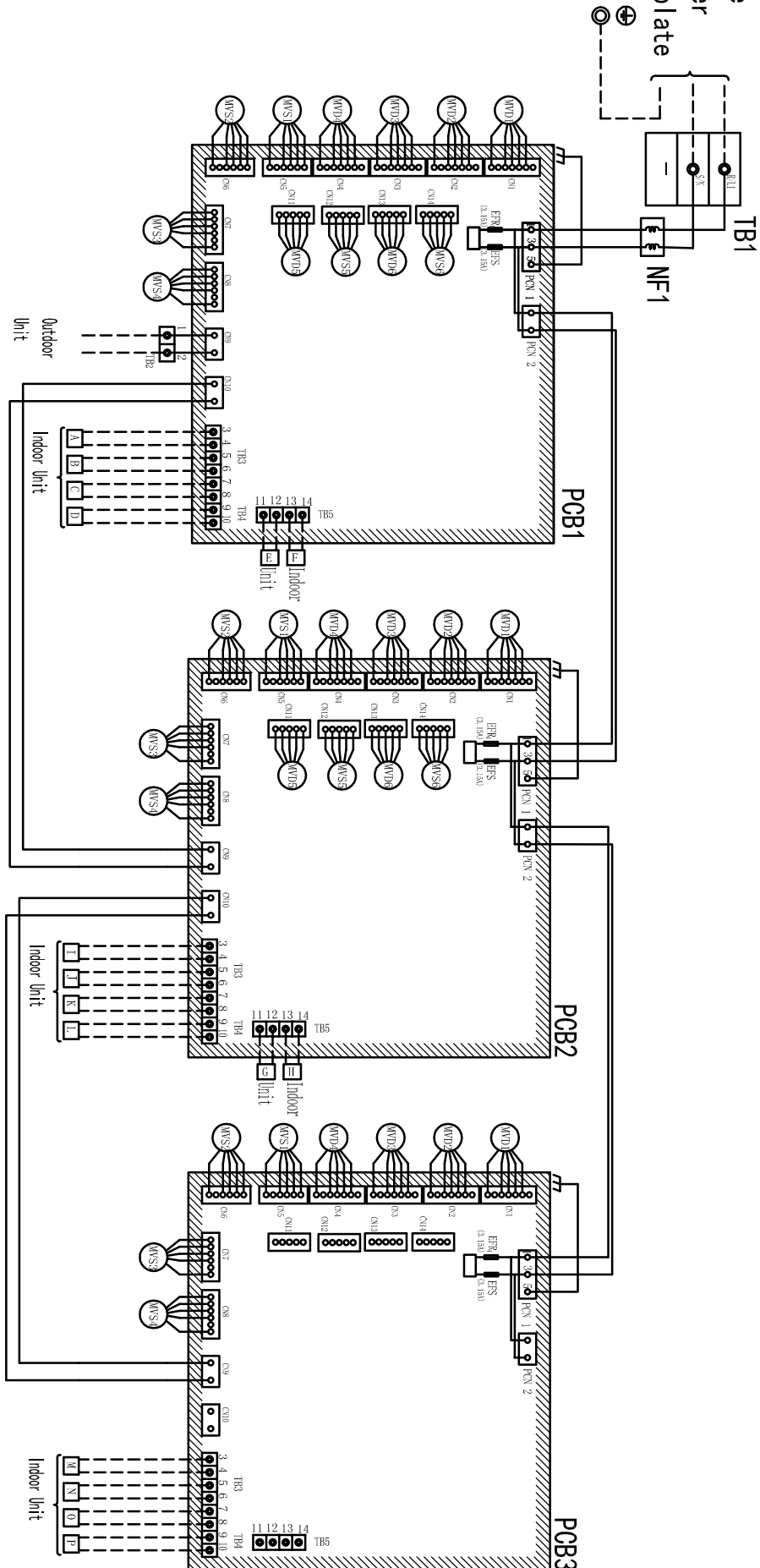

Mark	Name	Remark
PCB1, 2, 3	Printed Circuit Board	
TB1	Terminal Block	Power Supply
TB2	Terminal Block	Operating Line[Outdoor Unit]
TB3, 4, 5	Terminal Block	Operating Line[Indoor Unit]
MVD1~6 MVS1~6	Micro-Computer Control Expansion Valve	
NF1	Noise Filter	
EFR _i EFS _i	Fuse	

Mark	Torque to tighten the terminal	Screw Size
TB1	1.0~1.3 (N · m)	M4
TB2	1.0~1.3 (N · m)	
TB3,4,5	0.7~1.1 (N · m)	M3.5

Indoor Unit	Mark		
Indoor Unit A	TB3-3	MVD1	
	TB3-4	MVS1	
	Indoor Unit B	TB3-5	MVD2
		TB3-6	MVS2
	Indoor Unit C	TB4-7	MVD3
		TB4-8	MVS3
Indoor Unit D	TB4-9	MVD4	
	TB4-10	MVS4	
Indoor Unit E	TB5-11	MVD5	
	TB5-12	MVS5	
Indoor Unit F	TB5-13	MVD6	
	TB5-14	MVS6	
Indoor Unit G	TB5-11	MVD5	
	TB5-12	MVS5	
	Indoor Unit H	TB5-13	MVD6
		TB5-14	MVS6
	Indoor Unit I	TB3-3	MVD1
		TB3-4	MVS1
Indoor Unit J	TB3-5	MVD2	
	TB3-6	MVS2	
Indoor Unit K	TB4-7	MVD3	
	TB4-8	MVS3	
Indoor Unit L	TB4-9	MVD4	
	TB4-10	MVS4	
Indoor Unit M	TB3-3	MVD1	
	TB3-4	MVS1	
	Indoor Unit N	TB3-5	MVD2
		TB3-6	MVS2
	Indoor Unit O	TB4-7	MVD3
		TB4-8	MVS3
Indoor Unit P	TB4-9	MVD4	
	TB4-10	MVS4	

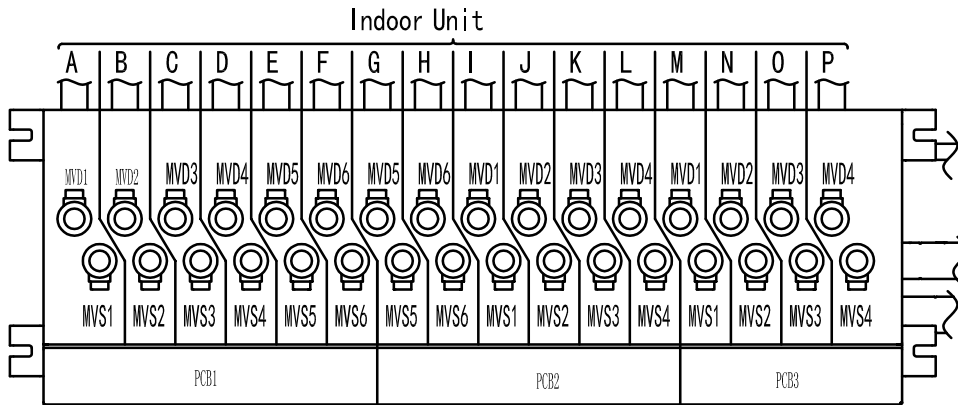

Arrangement of Micro-Computer Control
Expansion Valves (View of the Top)

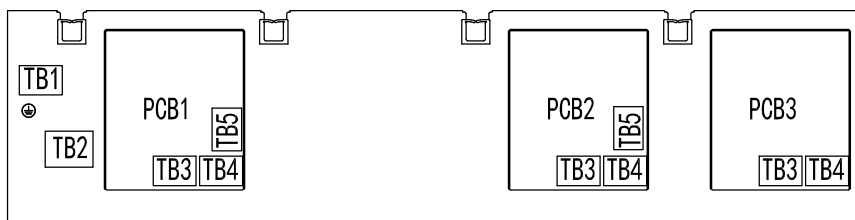

Electrical Control Box

4.3 Electrical Wiring and Settings

4.3.1 Switch Box HCHS-N(06/10)XA

Electrical Wiring

The electrical wiring connection for the Switch Box is shown below.

- Turn OFF the main power switch and take off the electrical box cover of Switch Box.
- Connect the power supply wiring to L1 and N on the terminal block TB1, and connect ground wiring to the terminals in the electrical box.
- Connect the communication cable to “1”, “2”, “3” and “4” on the terminal block TB2 mounted on PCB1.
- Tightly clamp the wires using the cable clamp inside the electrical box.
- Attach the electrical box cover after completing the wiring work.

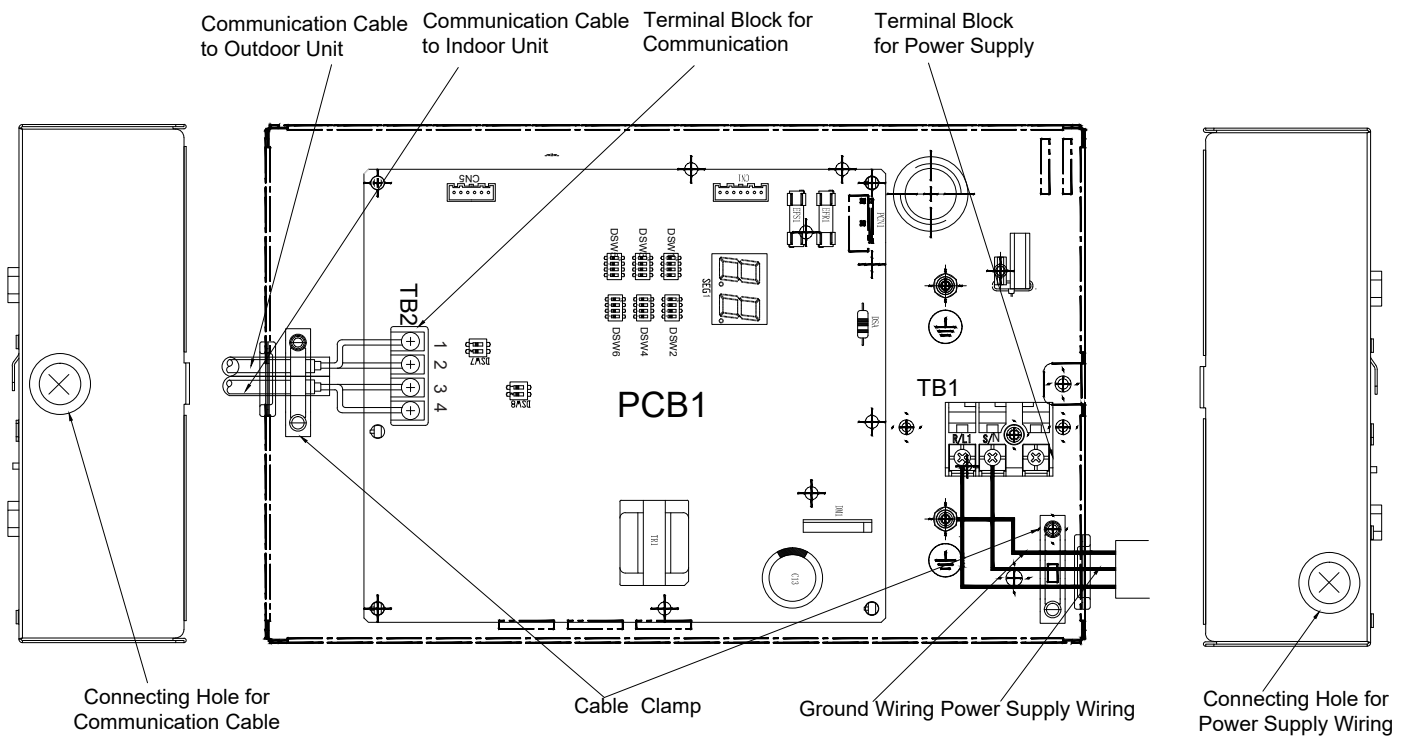

◆ Electrical Wiring Connection

- Perform the electrical wiring work for the Switch Boxes. Select the wire size according to the table below.
- Pay attention to the marks on the terminal block when connecting wires for Switch Box and indoor unit / outdoor unit.

Model	Power Supply	ELB (A/mA)	Earth Wire Size (mm ²)	Power Source Cable Size EN60 335-1(mm ²) *1	Communication Cable Size EN60 335-1 (mm ²)*1	CB (A)	Maximum Current (A)
HCHS-N06XA	220-240V ~ 50Hz	15/30	2.0	0.75	0.75	3.15	0.1
HCHS-N10XA	208-230V ~ 60Hz						

NOTE

- Follow local codes and regulations when selecting field wires.
- The wire sizes marked with *1 in the above table are selected at the maximum current of the unit according to the European Standard, EN60 335-1. Use the wires which are not lighter than the ordinary tough rubber sheathed flexible cord (code designation H05RN-F) or ordinary polychloroprene sheathed flexible cord (code designation H05RN-F).
- Use a shielded cable for the transmitting circuit and connect it to ground.

Setting of DIP Switches

DSWs for the Switch Box HCHS-N06XA/N10XA are set as shown below .

TURN OFF the power supply before adjusting DIP switch settings. Otherwise, the settings will be invalid and not take effect.

- Setting before shipping

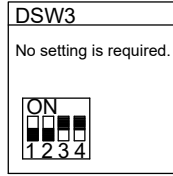
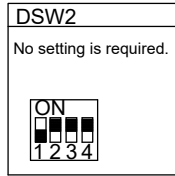
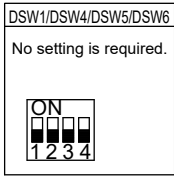

- Setting of forced opening of MVS and MVD. Setting on DSW1

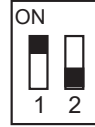

MVS= 0
MVD=100%



MVS=100%
MVD= 0



MVS=100%
MVD=100%

- Fuse Recovery

In the case of applying high voltage to terminals of TB2, the 0.5A fuse on the PCB is cut.

In such a case, first reconnect the wiring correctly to the terminal block, and then set the pin to ON.

- DSW8(for TB2-1/2)



Factory Setting Fuse Recovery

- DSW7(for TB2-3/4)



Factory Setting Fuse Recovery

NOTICE

All indoor and outdoor units must be shut down prior to attempting to make DIP Switch adjustments, otherwise, the settings will not take effect.

NOTE

The “■” mark indicates the position of DIP switches. Figures show setting before shipment.

4.3.2 Switch Box HCHM-N(04~16)XA

Electrical Wiring

The electrical wiring connection for the Switch Box is shown below.

- Turn OFF the main power switch and take off the electrical box cover of Switch Box.
- Connect the power supply wiring to L1 and N on the terminal block TB1, and connect ground wiring to the terminals in the electrical box.
- Connect the communication cable between the outdoor unit and Switch Box to TB2 of the Switch Box. Connect the communication cable between the Switch Box and indoor unit to TB3, TB4 and TB5 of the Switch Box. Ensure that the communication cable between the Switch Box and indoor unit is connected to the same letter as piping connection.
(Tightening Torque: 1.0 to 1.3 N.m (0.7 to 1.0 ft.lbs)).
- Tightly clamp the wires using the cable clamp inside the electrical box.
- Attach the electrical box cover after completing the wiring work.

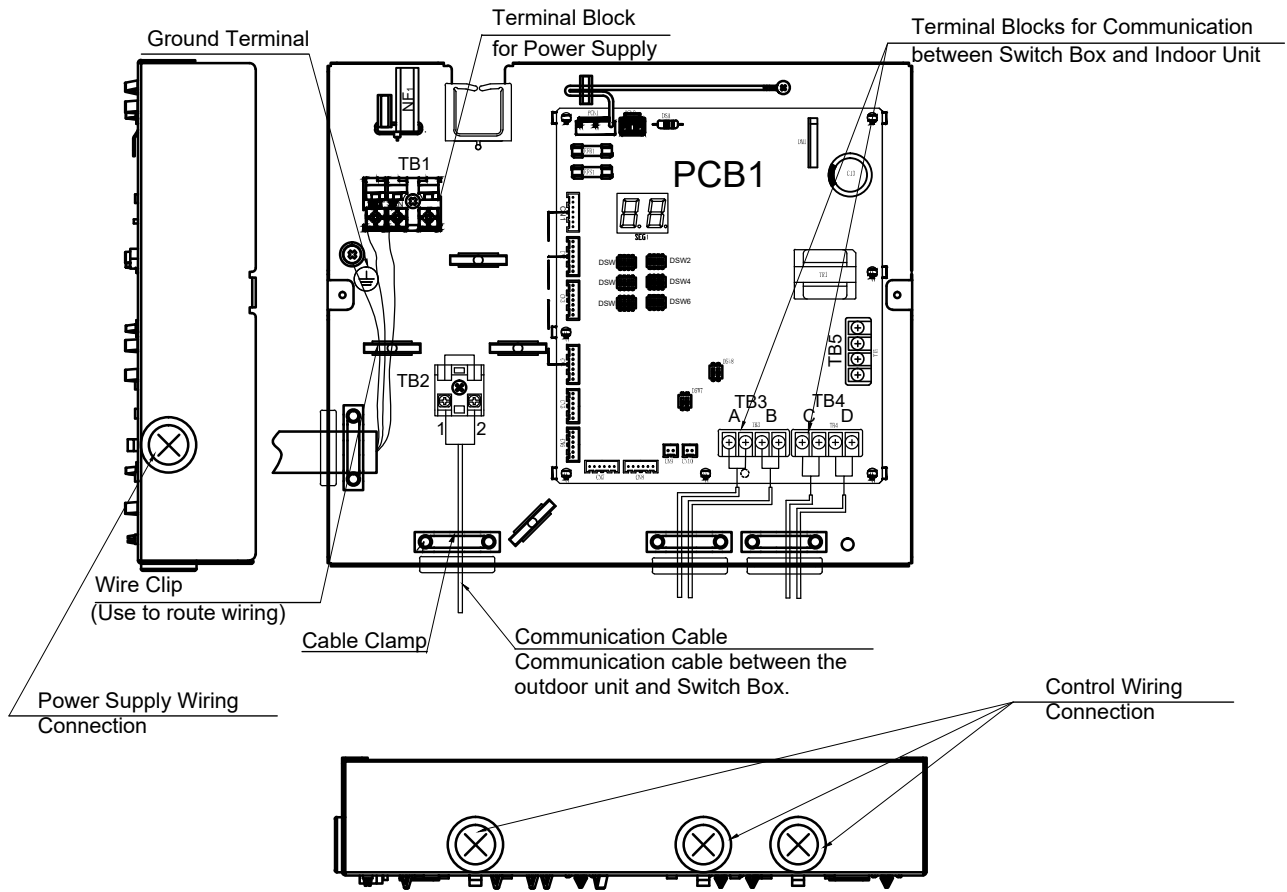

(a) HCHM-N04XA

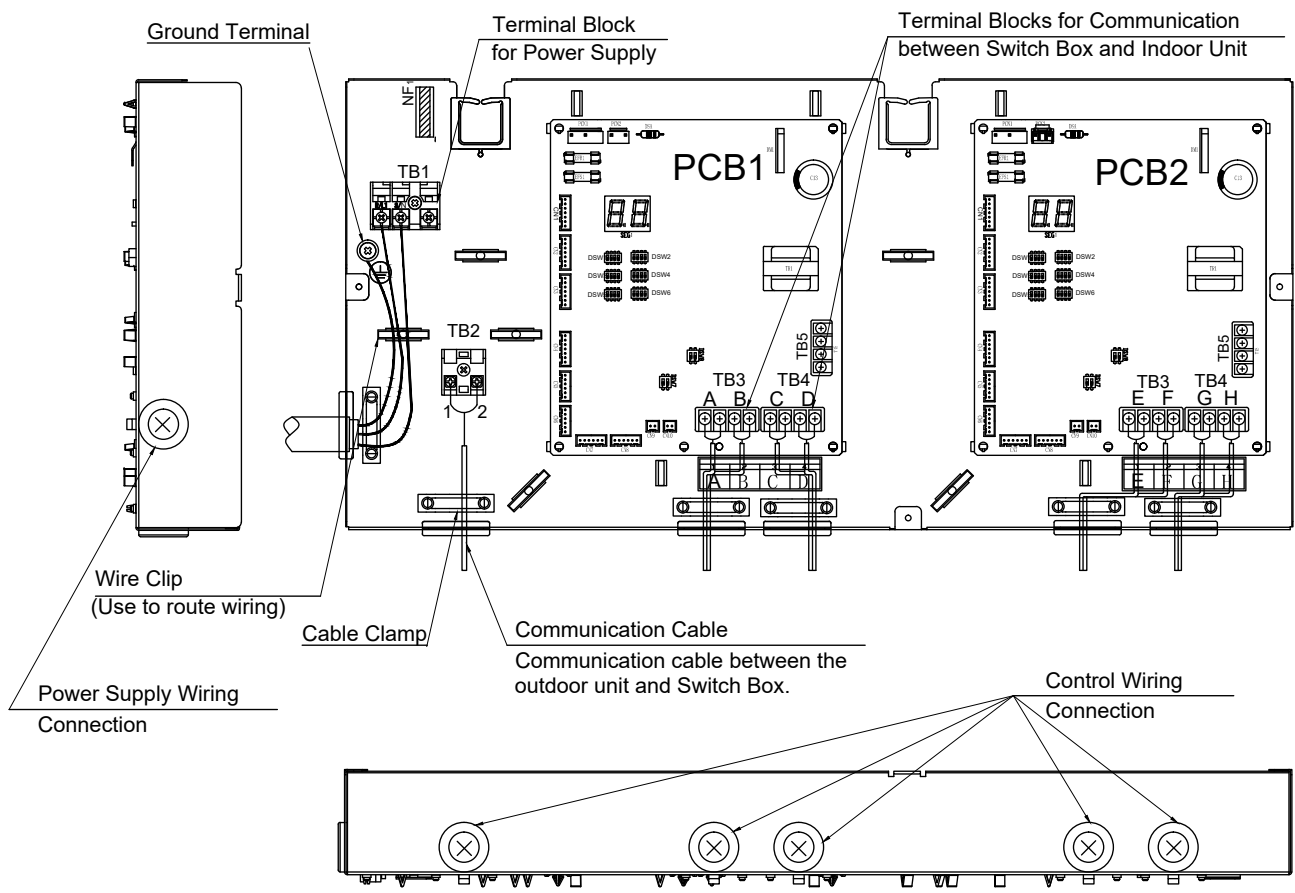

(b) HCHM-N08XA

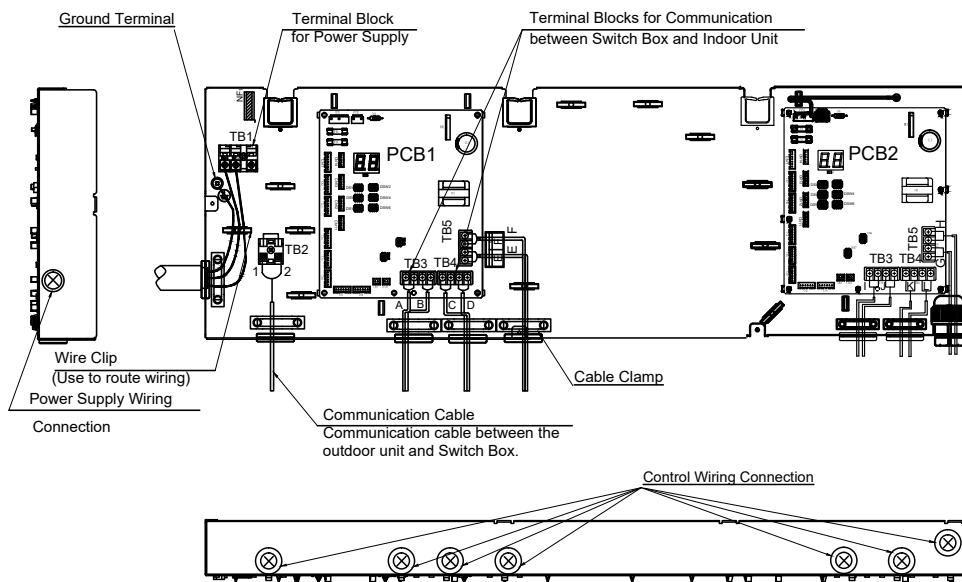

(c) HCHM-N12XA

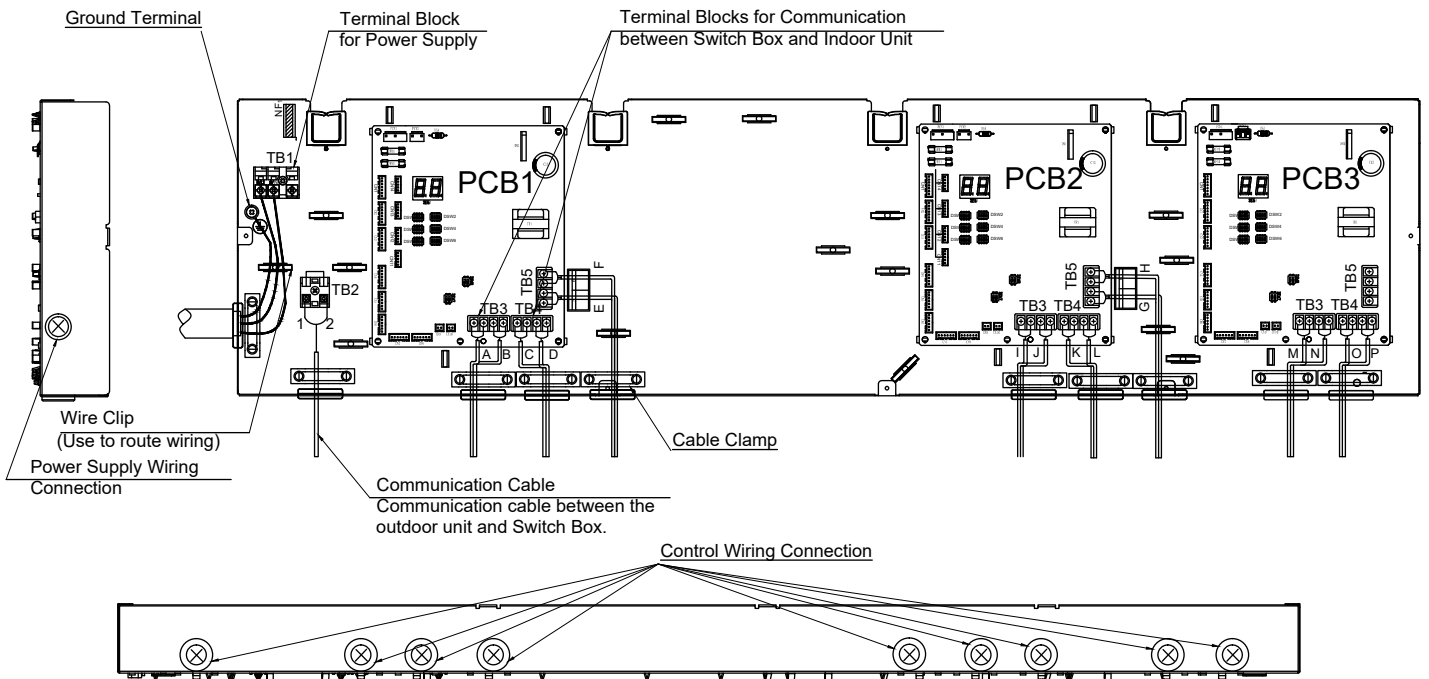

(d) HCHM-N16XA

TB1: Terminal Block for Power Supply; TB2: Terminal Block for Communication;
 TB3, TB4: Terminal Block for Communication

◆ **Electrical Wiring Connection**

- Perform the electrical wiring work for the Switch Boxes. Select the wire size according to the table below.
- Pay attention to the marks on the terminal block when connecting wires for Switch Box and indoor unit / outdoor unit.

Model	Power Supply	Earth Wire Size (mm ²)	Earth Wire Size (mm ²)	Power Source Cable Size	Transmitting Cable Size	CB (A)	Maximum Current (A)
				EN60 335-1(mm ²) *1	EN60 335-1 (mm ²)*1		
HCHM-N04XA	220-240V ~ 50Hz ; 208-230V ~ 60Hz	2.0	15/30	0.75	0.75	3.15	0.2
HCHM-N08XA							0.4
HCHM-N12XA							0.6
HCHM-N16XA							0.8

NOTE

- Follow local codes and regulations when selecting field wires.
- The wire sizes marked with *1 in the above table are selected at the maximum current of the unit according to the European Standard, EN60 335-1. Use the wires which are not lighter than the ordinary tough rubber sheathed flexible cord (code designation H05RN-F) or ordinary polychloroprene sheathed flexible cord (code designation H05RN-F).
- Use a shielded cable for the transmitting circuit and connect it to ground.

Setting of DIP Switches

DSWs for the Switch Box HCHM-N04XA/N08XA/N12XA/N16XA are set as shown below .

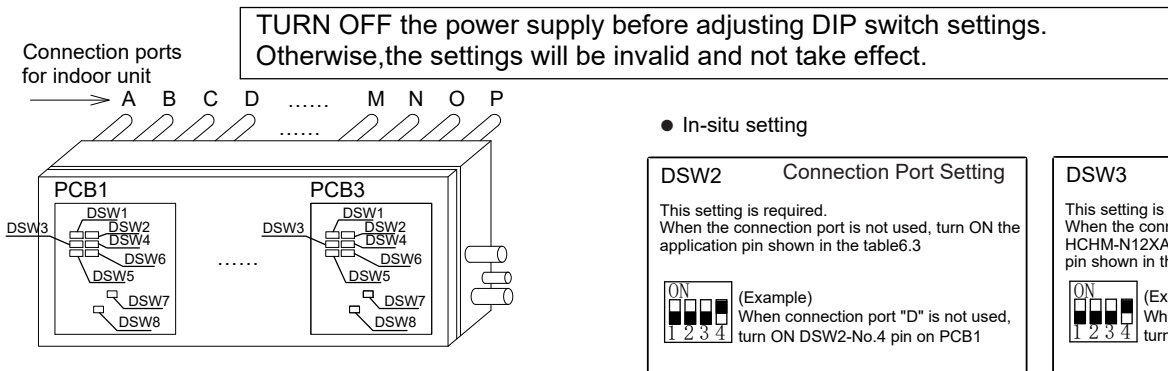

- Setting before shipping

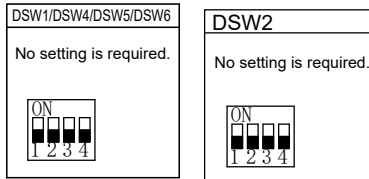

Setting before shipping for PCB1/PCB2 of HCHM-N04XA/N08XA and for PCB3 of HCHM-N16XA.

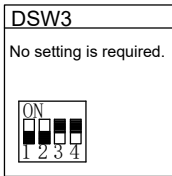

Setting before shipping for PCB1/PCB2 of HCHM-N012XA and N16XA.

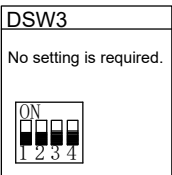

- Setting of forced opening of MVS and MVD. Setting on DSW1

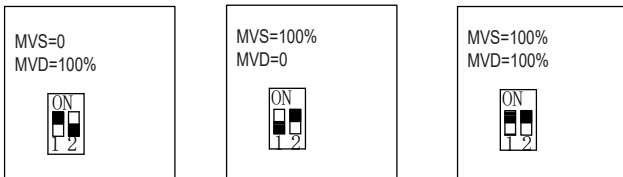
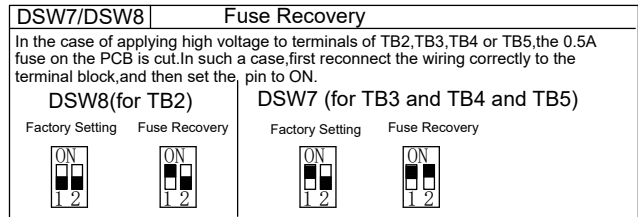

Table 6.3 Cross reference table of DIP switch settings and connection ports for indoor unit.

MODELS	HCHM-N08XA							
	HCHM-N04XA				HCHM-N08XA			
Connection ports for indoor unit	A	B	C	D	E	F	G	H
PCB No.	PCB1				PCB2			
DSW2 Pin No.	1	2	3	4	1	2	3	4

MODELS	HCHM-N12XA								HCHM-N16XA							
	HCHM-N12XA				HCHM-N12XA				HCHM-N16XA							
Connection ports for indoor unit	A	B	C	D	E	F	G	H	I	J	K	L	M	N	O	P
PCB No.	PCB1				PCB2				PCB3							
DSW2 Pin No.	1	2	3	4					1	2	3	4	1	2	3	4
DSW3 Pin No.					3	4	3	4								



NOTE

The "■" mark indicates the position of DIP switches. Figures show setting before shipment.

NOTICE

All indoor and outdoor units must be shut down prior to attempting to make DIP Switch adjustments, otherwise, the settings will not take effect.

5. Sound Data

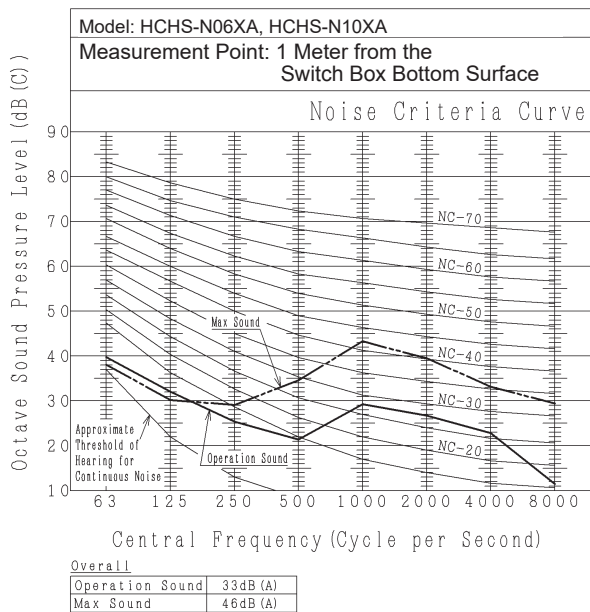

NOTE

1. The readings were taken in anechoic chamber. Sound in actual status may get bigger due to surroundings noise or echo. Take noise source into consideration to look for proper installation location.
2. Switch Box operation sound may be heard even if the indoor unit has stopped while the outdoor units are in operation and the other indoor units are at Thermo-ON.
3. "Operation Sound" is the Switch Box operation sound when the whole system is in either cooling or heating operation.
(Not in cooling and heating operation)
4. "Maximum Sound" is the maximum value of Switch Box operation sound while the unit is in cooling and heating operation or defrosting.
5. The maximum sound may be exceeded during transient operation such as switching to Defrosting Mode. Ensure the installation place.
Do not install the Switch Box in a place near bedrooms or hospital rooms.(Refer to the Installation Manual.)

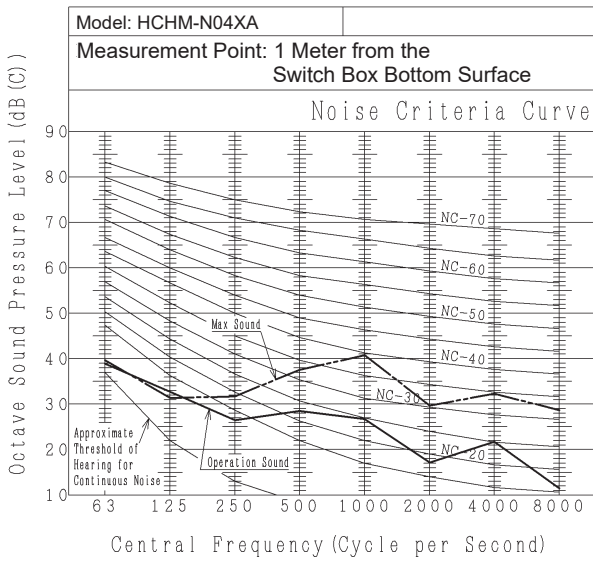

Overall	
Operation Sound	31dB (A)
Max Sound	43dB (A)

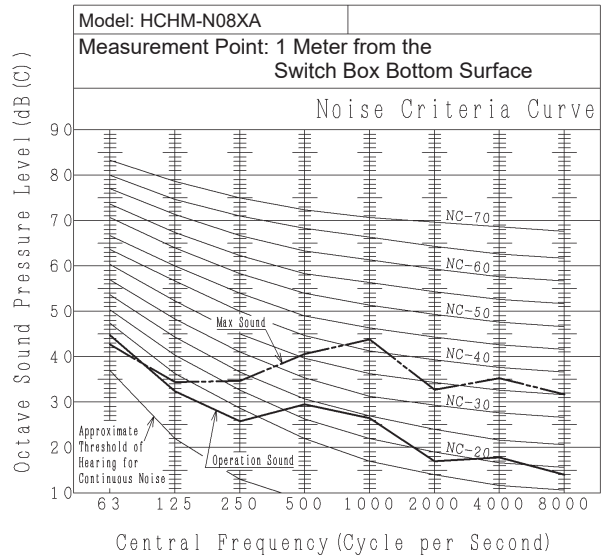

Overall	
Operation Sound	31dB (A)
Max Sound	46dB (A)

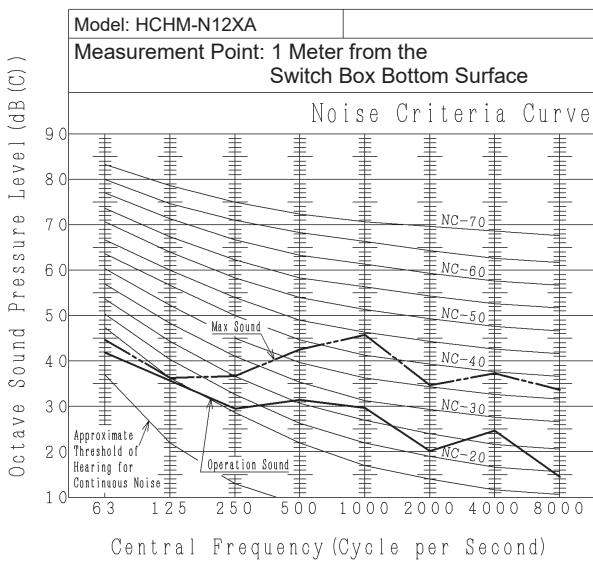

Overall	
Operation Sound	34dB (A)
Max Sound	48dB (A)

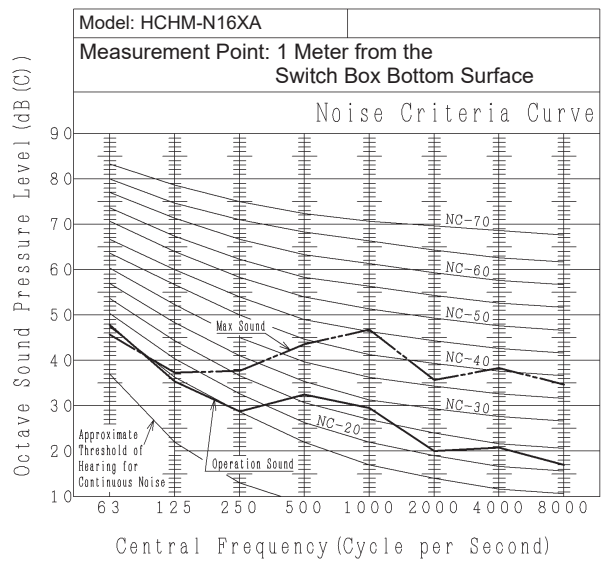

Overall	
Operation Sound	34dB (A)
Max Sound	49dB (A)

NOTE

1. The readings were taken in anechoic chamber. Sound in actual status may get bigger due to surroundings noise or echo. Take noise source into consideration to look for proper installation location.
2. Switch Box operation sound may be heard even if the indoor unit has stopped while the outdoor units are in operation and the other indoor units are at Thermo-ON.
3. "Operation Sound" is the Switch Box operation sound when the whole system is in either cooling or heating operation.(Not in cooling and heating operation)
4. "Maximum Sound" is the maximum value of Switch Box operation sound while the unit is in cooling and heating operation or defrosting.
5. The maximum sound may be exceeded during transient operation such as switching to Defrosting Mode. Ensure the installation place.
Do not install the Switch Box in a place near bedrooms or hospital rooms.
(Refer to the Installation Manual.)

6. Transportation and Handling

6.1 Transportation

Transport the product as close to the installation location as practicable before unpacking.

CAUTION

Do not put any material on the product.

6.2 Handling of Switch Box

WARNING

Do not put any foreign matters into the indoor unit and check to ensure that none exists in the Switch Box before the installation and test run. Otherwise, a fire or failure, or something similar may occur.

CAUTION

Be careful not to damage insulation materials of unit's surface when lifting.

6.3 Combination of Switch Box and Indoor Unit

Combination is as follows.

◆ HCHS-N06/10XA

Table 6.1 Combination of Indoor Unit

Model		HCHS-N06XA	HCHS-N10XA
Number of Branch (for Indoor Unit)		1	1
Single Unit per Branch	Maximum Total Capacity of All Connected Indoor Units	54kBtu/h (Max. 16.0kW/6.0HP/4.77RT)	96kBtu/h or less (Max. 28.0kW/10HP/8RT)
Multiple Units per Branch (*1)	Maximum Number of Connected Indoor Units per Branch	8	8
	Maximum Total Capacity of All Connected Indoor Units	54kBtu/h (Max. 16.0kW/6.0HP/4.77RT)	96kBtu/h or less (Max. 28.0kW/10HP/8RT)

(*1) When multiple indoor units are connected to the same Switch Box, they are controlled with the same operation mode.

NOTES:

- Exceeding the total capacity may cause insufficient performance and abnormal sound. Be sure to connect the Switch Box within the allowable total capacity.
- If the indoor unit total capacity is 96kBtu/h(28kW/10HP/8RT) for HCHS-N10XA, the performance may decrease approximately.

◆ HCHM-N(04~16)XA

Table 6.2 Combination of Indoor Unit

Model		HCHM-N04XA	HCHM-N08XA	HCHM-N12XA	HCHM-N16XA
Number of Branches (for Indoor Unit)		4	8	12	16
Single Unit Per Branch	Maximum Total Capacity of All Connected Indoor Units	154kBtu/h or less (Max. 44.8kW/16HP/12.73RT)	290kBtu/h or less (Max. 85.0kW/30HP/24.14RT)	290kBtu/h or less (Max. 85.0kW/30HP/24.14RT)	290kBtu/h or less (Max. 85.0kW/30HP/24.14RT)
	Maximum Total Capacity of Connected Indoor Units Per Branch	54kBtu/h or less (Max. 16.0kW/6HP/4.77RT)	54kBtu/h or less (Max. 16.0kW/6HP/4.77RT)	54kBtu/h or less (Max. 16.0kW/6HP/4.77RT)	54kBtu/h or less (Max. 16.0kW/6HP/4.77RT)
Multiple Units Per Branch	Maximum Number of Connected Indoor Units Per Branch	8	8	6	6
	Maximum Total Capacity of All Connected Indoor Units	154kBtu/h or less (Max. 44.8kW/16HP/12.73RT)	290kBtu/h or less (Max. 85.0kW/30HP/24.14RT)	290kBtu/h or less (Max. 85.0kW/30HP/24.14RT)	290kBtu/h or less (Max. 85.0kW/30HP/24.14RT)
	Maximum Total Capacity of Connected Indoor Units Per Branch	54kBtu/h or less (Max. 16.0kW/6HP/4.77RT)	54kBtu/h or less (Max. 16.0kW/6HP/4.77RT)	54kBtu/h or less (Max. 16.0kW/6HP/4.77RT)	54kBtu/h or less (Max. 16.0kW/6HP/4.77RT)

NOTES:

1. Exceeding the total capacity may cause insufficient performance and abnormal sound. Be sure to connect the Switch Box within the allowable total capacity.
2. In case of 76kBtu/h(22.4kW/8HP/6RT) or 96kBtu/h(28kW/10HP/8RT) type indoor unit connection: Only single unit per branch is allowed to be connected.
Up to two 76kBtu/h(22.4kW/8HP/6RT) or 96kBtu/h(28kW/10HP/8RT) type indoor units can be connected to the Switch Box within the "Maximum Total Capacity of All Connected Indoor Units" shown in above table.
Make sure to increase the pipe connection size by using the appropriate accessory pipe.

7. Installation

⚠ DANGER

Do not install the Switch Box in a flammable environment to avoid fire or an explosion.

⚠ WARNING

- Check to ensure that the ceiling slab is strong enough.
- Do not install the Switch Box outdoors. If installed outdoors, an electric hazard or electric leakage may occur.
- Installation **WARNING**: Ensure that all safety features, disconnects and interlocks are in place and functioning properly prior to putting the equipment into operation. Never by-pass or jump-out any safety device or switch.

7.1 Factory-Supplied Accessories

Check to ensure that the following accessories are packed with the Switch Box.







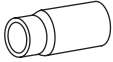
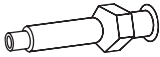
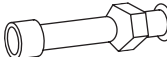
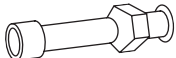
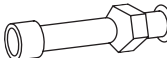
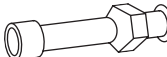

NOTE

If any of these accessories are not packed with the unit, please contact your distributor.

Table 7.1 Factory-Supplied Accessories





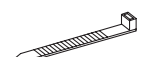
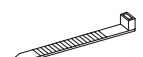









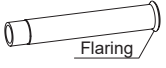
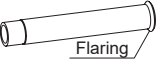
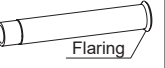
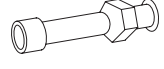
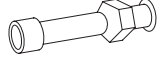



Single Branch Switch Box(HCHS-N06/10XA)

Unit: mm (inch)

No.	Accessory	HCHS-N06XA		Q'ty	HCHS-N10XA		Q'ty	
(1)	Reducer	ID 15.88 (ID 5/8)	 ID 19.05 (ID 3/4)	1	-	-	-	
(2)	Accessory Pipe (for Flare Nut)	OD 12.7 (OD 1/2)	 OD 15.88 (OD 5/8)	2	ID 22.4 (ID 7/8)	 OD 19.05 (OD 3/4)	2	
(3)		ID 19.3 (ID 3/4)	 OD 19.05 (OD 3/4)	1	ID 19.3 (ID 3/4)	 OD 19.05 (OD 3/4)	2	
(4)		-	-	-	ID 19.3 (ID 3/4)	 OD 15.88 (OD 5/8)	1	
(5)	Insulation Material	ID 16 (ID 5/8)		2			1	
(6)		ID 20 (ID 13/16)		1	-		-	
(7)		ID 22 (ID 7/8)	-	-			2	
(8)		ID 38 (ID 1-1/2)			2			1
(9)		ID 43 (ID 1-11/16)			1			2
(10)	Clamp			6			6	

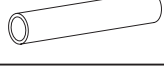
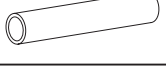
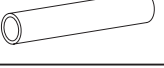
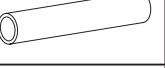
Multi Branch Switch Box(HCHM-N(04-16)XA)

Unit: mm (inch)

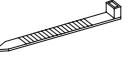
No.	Accessory	HCHM-N04XA	Q'ty	HCHM-N08XA	Q'ty	HCHM-N12XA	Q'ty	HCHM-N16XA	Q'ty	
(1)	Accessory Pipe	$\phi 15.88$ (5/8) → ID $\phi 12.9$ (1/2)		4		8		12		16
(2)		$\phi 9.52$ (3/8) → ID $\phi 6.5$ (1/4)		4		8		12		16
(3)		$\phi 15.88$ (5/8) → ID $\phi 19.3$ (3/4)		2		2		2		2
(4)		$\phi 15.88$ (5/8) → ID $\phi 22.2$ (7/8)		1		2		2		2
(5)	Insulation Material	ID 26 (ID 1)		4		8		12		16
(6)		ID 35 (ID 1-3/8)		4		8		12		16
(7)	Clamp		17		34		51		68	

7.2 Initial Check

- Install the Switch Box with a proper clearance around it for maintenance working space, as shown in Figure 7.1 below.

Single Branch Switch Box(HCHS-N06/10XA)

Unit: mm (inch)

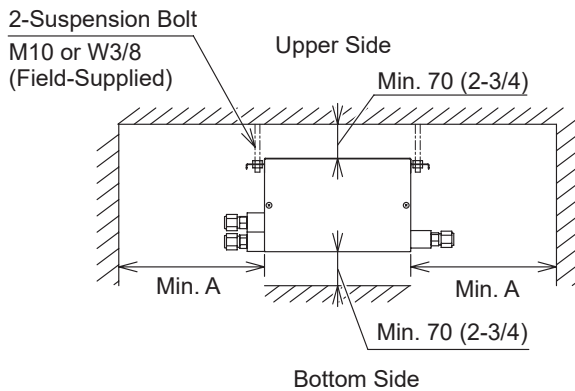
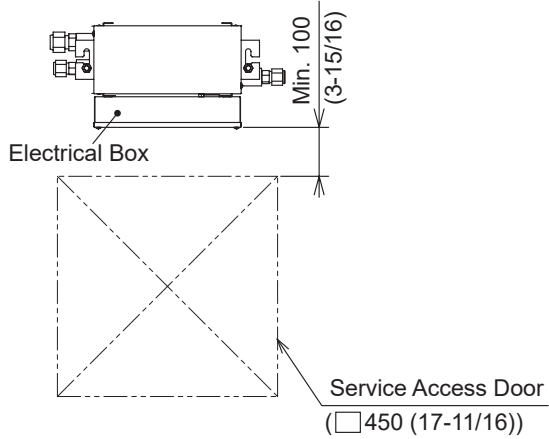

Model	Size	A
HCHS-N06XA	300 (11-13/16)	
HCHS-N10XA	400 (15-3/4)	

Multi Branch Switch Box(HCHM-N(04-16)XA)

Unit: mm (inch)

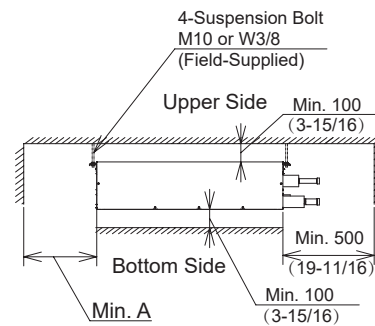
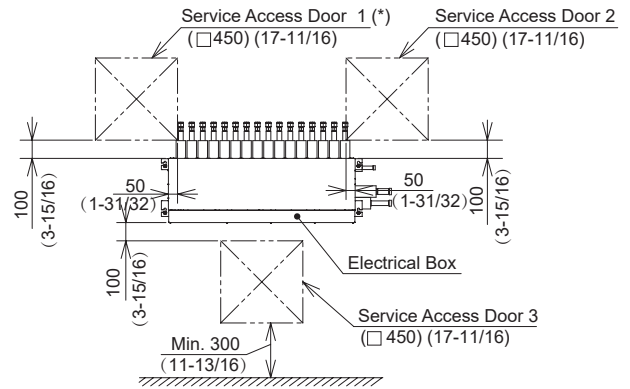

* Service access door 1 is required for models HCHM-N04XA, HCHM-N08XA, HCHM-N12XA and HCHM-N16XA.

Model	Size	A
HCHM-N04XA	100(3-15/16)	
HCHM-N08XA		
HCHM-N12XA		400(15-3/4)
HCHM-N16XA		

Purpose of Each Service Access Door

Name	Purpose
Service Access Door 1	Use during inspection of indoor unit connecting side.
Service Access Door 2	Use during inspection of indoor unit connecting side.
Service Access Door 3	Use during inspection of electrical components inside electrical box.

Figure 7.1 Service Space

- Check to ensure that the ceiling is sufficiently strong to sustain the Switch Box. If the ceiling is weak, abnormal sound and vibration may occur.
- When the electronic expansion valve in the Switch Box is activated, a change in the typical refrigerant flow sounds may be heard or perceived from the Switch Box. Take the following action to minimize the sound.
 - (A) Install the Switch Box inside the ceiling. As for the ceiling material, select a material like a plasterboard at least 9mm (1 inch), which minimizes operation sound.
 - (B) Do not install the Switch Box in a place near bedrooms or hospital rooms.
- When the operation is changed to cooling/heating mode, a change in the typical refrigerant flow sounds may be heard or perceived from the Switch Box.
Therefore, install the Switch Box in the ceiling of the corridor so that the refrigerant flowing sound may not be heard in the room.
- Do not install the Switch Box in a hot or humid place, such as a kitchen, to prevent condensation on the outer surface of the Switch Box.
When installing the Switch Box in such places, apply additional insulation.
- Pay attention to the following points when the Switch Box is installed in a hospital or other facility where there are electronic waves from medical equipment.
 - (A) Do not install the Switch Box where the electromagnetic wave is directly radiated to the electrical box or communication cable.
 - (B) Install the Switch Box and components as far as practicable or at least 3m (10 ft) from the electromagnetic wave radiator.
 - (C) Install a noise filter when the power supply emits harmful noises.
- Ensure the installation place is convenient for the refrigerant piping or electrical wiring connection.
- Do not drill, or drive screws into the cabinet. Use only mounting points provided.
- In case the Switch Box is required to move from the ceiling, prepare another service access door.

7.3 Suspension Bolts

Step 1

- (1) Select a final location and installation direction of the Switch Box.
Pay careful attention to the space for the piping, wiring and maintenance.
- (2) Mount suspension bolts.
- (3) Mount the suspension bolts in the slotted hole on the electrical box side as shown in Figure 7.2
- (4) Contact a qualified contractor or carpenter for the ceiling treatment.

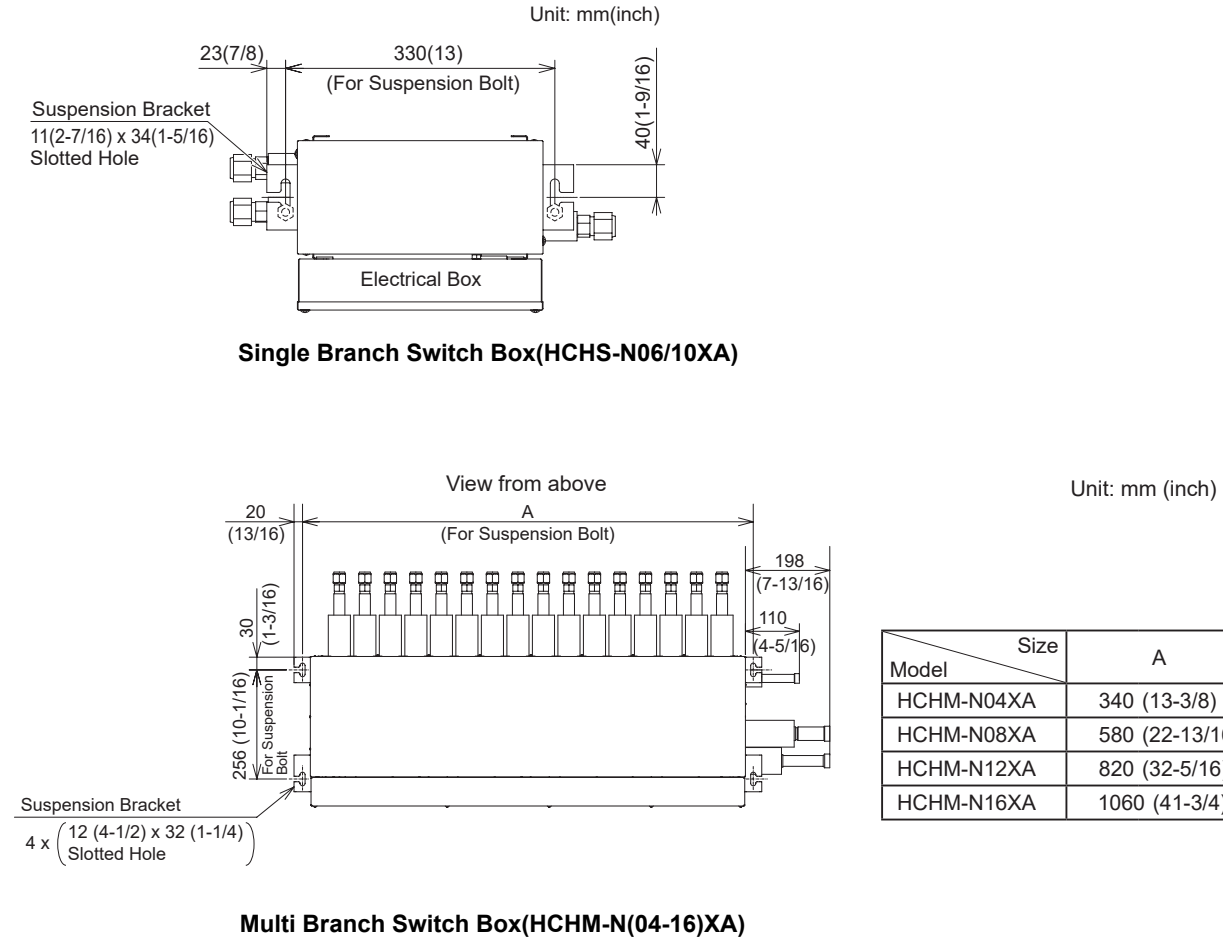
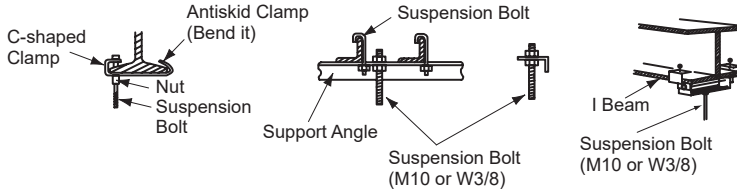

Figure 7.2 Position of Suspension Bolts

Step 2

Mount suspension bolts, as shown in Figure 7.3.

● For Steel Beam



● For Wooden Beam

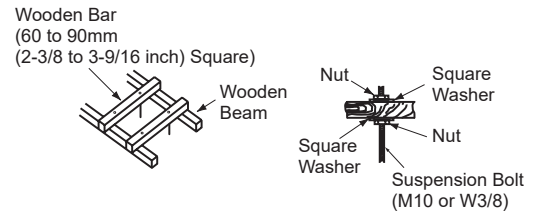

● For Concrete Slab

(1) Hole-In Anchor

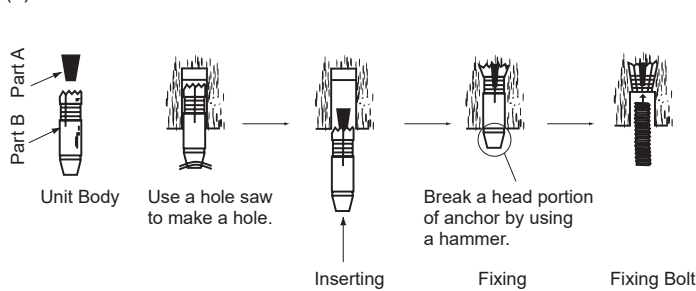

● For Reinforcing Steel

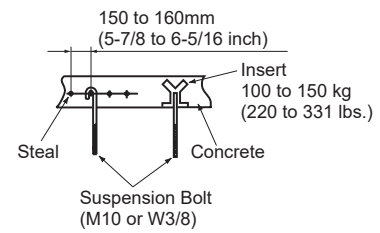

(2) Resin Capsule

Use the resin capsule within the warranty period. Resin capsules deteriorate over time and should be used within six months of the manufacturing date.

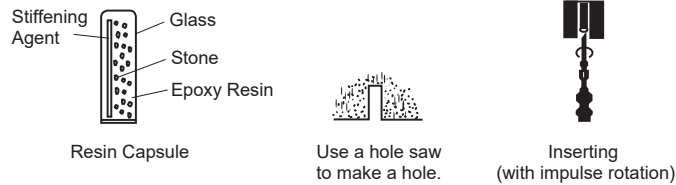

After inserting, do not rotate or put any force until resin is hardened. Required time is as shown in the table at right.

Use a suspension bolt with 30 to 45° sloping edge.

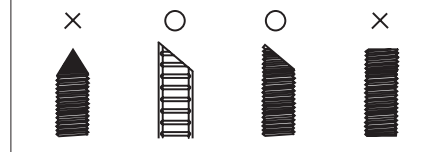

Ambient Temp.	Time
20°C (68°F)	Min. 30min.
15°C (59°F)	Min. 1hr.
10°C (50°F)	Min. 2hr.
5°C (41°F)	Min. 4hr.
0°C (32°F)	Min. 8hr.

NOTE:

- Use a suspension bolt (W3/8, Metric screw thread: M10).
- Prepare washer and nut.

Figure 7.3 Mounting of Suspension Bolts

7.4 Installation

7.4.1 Changing the Location of the Electrical Box

Depending on the installation space, changing the location of the electrical box is available.

When changing the location of the electrical box, follow the procedures below:

- (1) Remove the service cover for the electrical box.
- (2) Remove the service cover for the electronic expansion valve.
- (3) Remove the electrical box.
- (4) Remove the wiring from the wire clip and edge saddle, and move the electrical box.
After moving the electrical box, put the wiring into the edge saddle and bound with the wire clip.
(Refer to "Enlarged View of A" below.)
- (5) Mount the electrical box.
- (6) Rotate the service cover for the electronic expansion valve 180 degrees and mount it.
- (7) Mount the service cover for the electrical box.

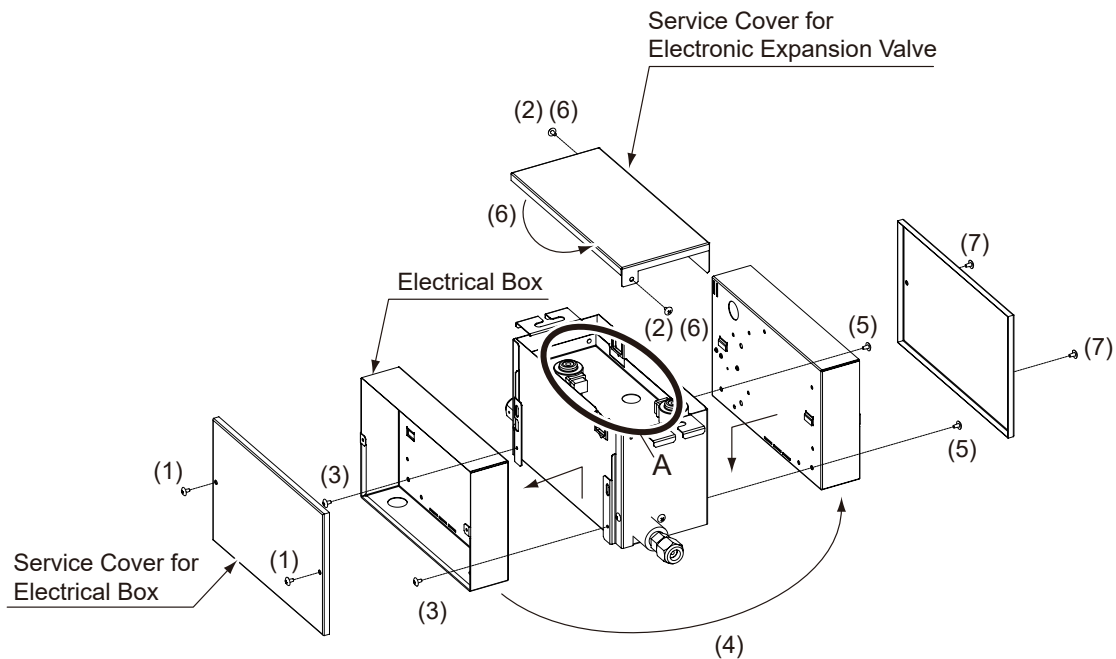

Enlarged View of A

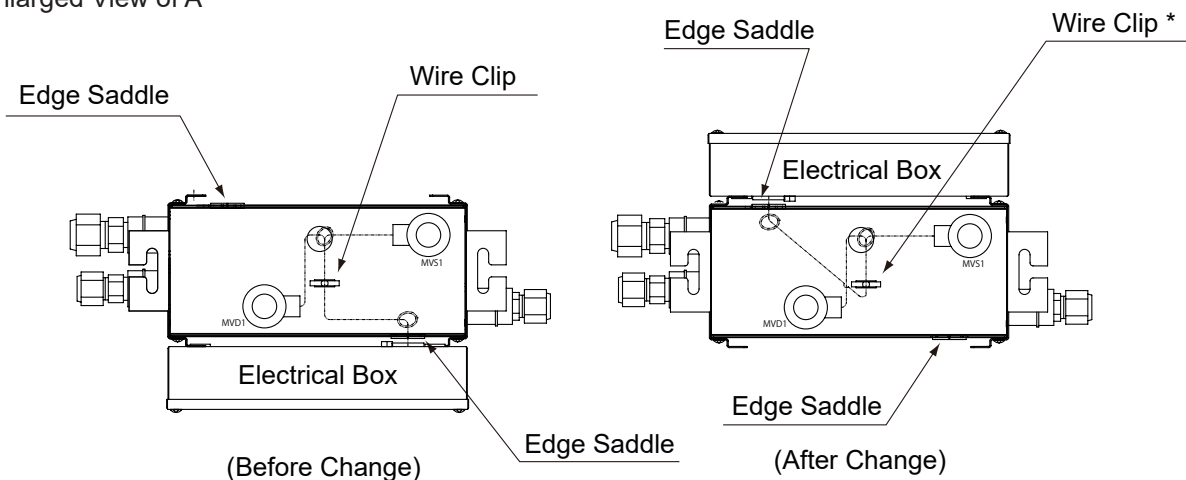

* Make sure that the wiring is bound with the wire clips in order to prevent the electrical box from entering water.

7.4.2 Marking of the Positions of the Suspension Bolts and Wiring Connections

- (1) Mark the positions of the suspension bolts, refrigerant piping connections and wiring connection.
- (2) Installation dimensions are shown in "Dimensional Data".

Mounting and Hanging the Switch Box

- (1) Place nuts and washers onto the suspension bolts before installing the Switch Box.

NOTE:

Make sure to use washers for installing the suspension bolts to the suspension brackets. Install the washer with the insulation side facing down for suspended installation applications. This way, the washers themselves remain in position on the suspension bolts during the installation phase.

Field-Supplied Parts

Single Branch Switch Box(HCHS-N06/10XA)

- * Suspension Bolt: 2-M10 or W3/8
- * Nut: 6-M10 or W3/8
- * Washer: 4-M10 or W3/8

Multi Branch Switch Box(HCHM-N(04-16)XA)

- * Suspension Bolt: 4-M10 or W3/8
- * Nut: 12-M10 or W3/8
- * Washer: 8-M10 or W3/8

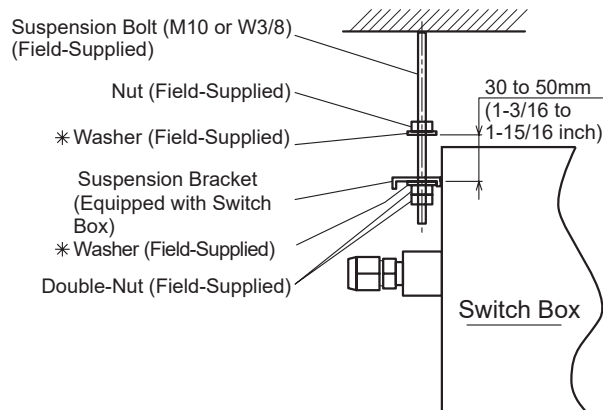
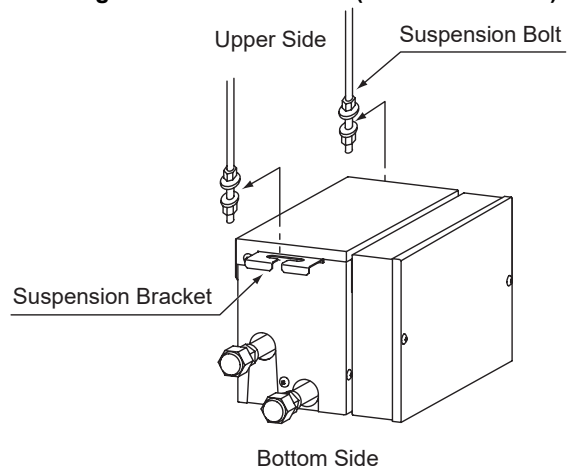

Figure 7.4 Suspension

(2) Hanging the Switch Box

- (a) Hang the Switch Box by putting hands on the bottom of the cabinet.
- (b) Insert the suspension bolt into the groove part of the suspension bracket as shown in Figure 7.5. Ensure that the washers are correctly affixed to the suspension bracket.
- (c) After the hanging work, the piping and wiring connection work is required inside the ceiling in the gap between the roof and ceiling so it is not visible. Therefore, determine the drawing direction of the pipe after selecting the installation location of the Switch Box. Before doing the hanging work, carry out the piping and wiring work up to the connecting positions.
- (d) Keep the Switch Box level to the ceiling surface. If the Switch Box is not level, a malfunction may occur.
- (e) Tighten the nuts of the suspension bolt with the suspension bracket after adjustment is completed. Adhesive must be applied to the nuts in order to prevent them from loosening.

Single Branch Switch Box(HCHS-N06/10XA)



Multi Branch Switch Box(HCHM-N(04-16)XA)

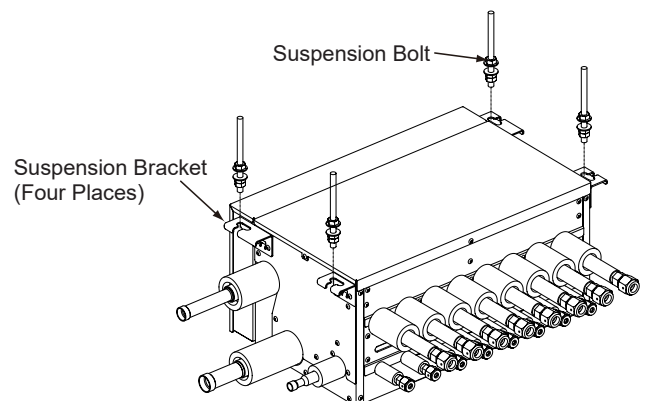

Figure 7.5 Hanging Method

8 Refrigerant Piping Work

■ HCHS-N06/10XA

Provide the refrigerant pipe in the field.

Make sure that the refrigerant pipe is connected to the same refrigerant cycle unit.

(1) Position of Piping Connection

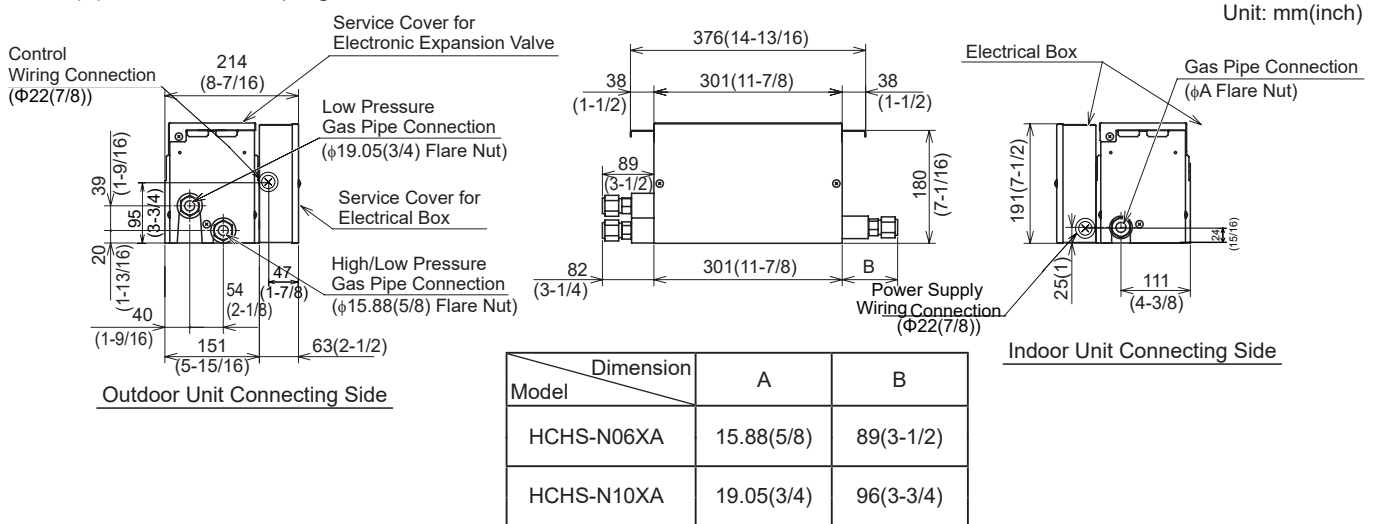

(2) Selecting Piping Size

- Select the size for the high/low pressure gas pipe, low pressure gas pipe and gas pipe according to the table 8.1. The size depends on the indoor unit total capacity connected downstream of the Switch Box .
- In case that the piping size from Table 8.1 and the piping connection size for Switch Box from Table 8.2 are different, use an accessory pipe according to the item 8.2(3).
- As for the BRANCH PIPE branch or header branch, refer to Technical Catalog for Outdoor Unit.

Table 8.1 Connected Indoor Unit Capacity and Piping Size

Unit: mm(inch)

Model	Connected Indoor Unit Capacity	Low Pressure Gas Pipe	High/Low Pressure Gas Pipe	Gas Pipe
HCHS-N06XA	1.5HP or less (4.3kW or less) (14kBtu/h or less)(1.22RT or less)	φ15.88(5/8)	φ12.7(1/2)	φ12.7(1/2) *
	1.5 to 4.0HP (4.3 to 11.2kW) (14 to 38kBtu/h)(1.22 to 3.18RT)	φ15.88(5/8)	φ12.7(1/2)	φ15.88(5/8)
	4.0 to 6.0HP (11.2 to 16kW) (38 to 54kBtu/h)(3.18 to 4.77RT)	φ19.05(3/4)	φ15.88(5/8)	φ15.88(5/8)
HCHS-N10XA	6.0 to 8.0HP (16 to 22.4kW) (54 to 76kBtu/h)(4.77 to 6RT)	φ19.05(3/4)	φ15.88(5/8)	φ19.05(3/4)
	8.0 to 10.0HP (22.4 to 28kW) (76 to 96kBtu/h)(6 to 8RT)	φ22.2(7/8)	φ19.05(3/4)	φ22.2(7/8)

*: In case that a branch is located downstream of the Switch Box and also the connected indoor unit capacity is 1.5HP (4.3kW,14kBtu/h, 1.22RT) or less, use φ15.88 for the gas pipe.

Table 8.2 Piping Connection Size for Switch Box

Unit: mm(inch)

Model	Low Pressure Gas Pipe	High/Low Pressure Gas Pipe	Gas Pipe
HCHS-N06XA	φ19.05(3/4)	φ15.88(5/8)	φ15.88(5/8)
HCHS-N10XA	φ19.05(3/4)	φ15.88(5/8)	φ19.05(3/4)

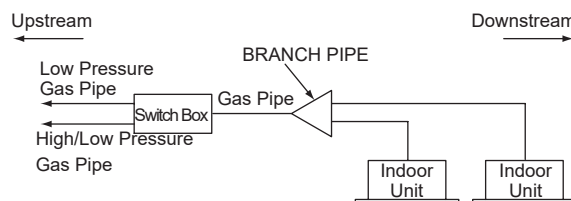

● Piping Work for Switch Box

Refrigerant piping size depends on the combinations with the outdoor unit. Refer to the installation and maintenance manual for the outdoor unit. Perform piping work for the Switch Box according to the following figure.

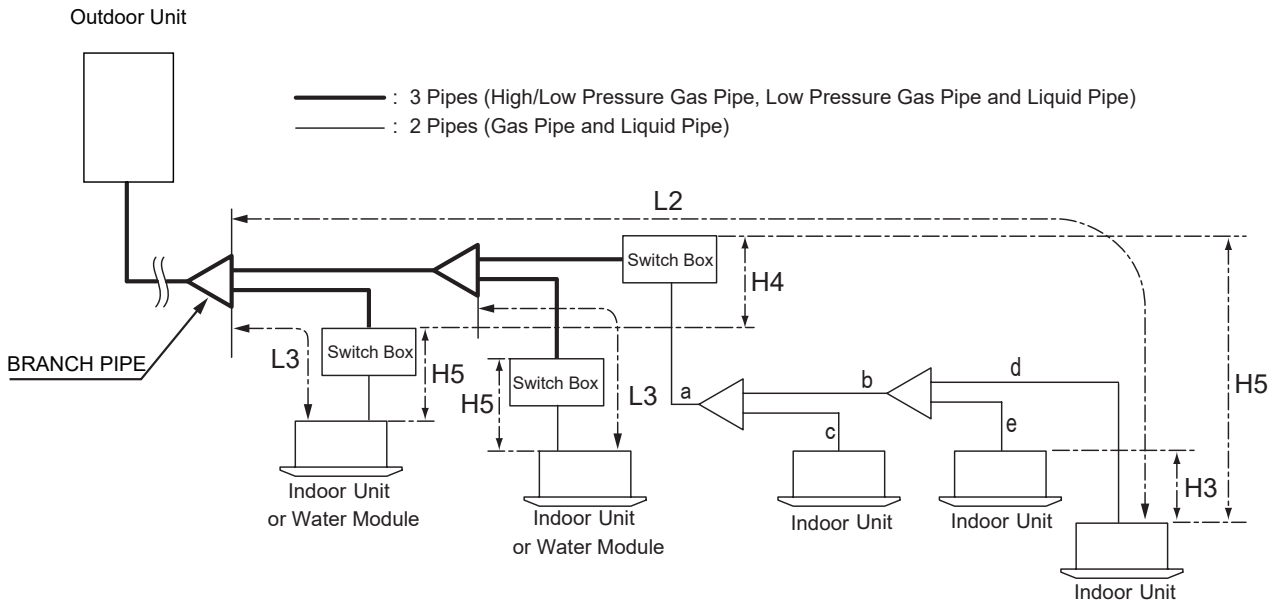

Item		Mark	Allowable Piping Length
Piping Length	Maximum Piping Length between BRANCH PIPE of 1st Branch and Terminal Indoor Unit	L2	≤ 90m (295 ft) ¹
	Maximum Piping Length between Each BRANCH PIPE and Each Indoor Unit	L3	≤ 40m (131 ft) ²
	In Case there is Branch after Switch Box, Total Piping Length from Switch Box to Each Connected Indoor Unit per Branch	a+b+c+d+e	≤ 40m (131 ft)
Height Difference	In Case there is Branch after Switch Box, Height Difference between Indoor Units Connected to Same Connection Port of Switch Box	H3	< 4m (13 ft)
	Height Difference between Switch Boxes	H4	< 15m (49 ft)
	Height Difference between Switch Box and Indoor Unit	H5	Refer to NOTE 3.

NOTES:

1. When the piping length from the first branch to the terminal indoor unit exceeds 40m (131 ft), there are restrictions. Refer to the installation and maintenance manual for the outdoor unit.
2. If the piping length (L3) between each BRANCH PIPE and indoor unit is considerably longer than other indoor unit, refrigerant may not flow well, and may lessen the unit's performance compared to other models. (Recommended Piping Length: Within 15m (49 ft))
3. Recommended height difference between Switch Box and indoor unit is within 15m (49 ft). If the height difference exceed this value, it may cause a decrease of operating performance.
4. Each Water Module must occupy one branch of Switch Box exclusively.

(3) Piping Connection

Perform the piping connection according to Table 8.1.

Unit: mm (inch)

Connected Indoor Unit Capacity: Q	HCHS-N06XA
$Q \leq 6.3\text{kW}$ $(Q \leq 22\text{kBtu/h})$ $(Q \leq 1.79\text{RT})$	
$6.3 < Q < 16.0\text{kW}$ $(22 < Q < 54\text{kBtu/h})$ $(1.79 < Q < 4.77\text{RT})$	
$Q = 16.0\text{kW}$ $(Q = 54\text{kBtu/h})$ $(Q = 4.77\text{RT})$	

Unit: mm (inch)

Connected Indoor Unit Capacity: Q	HCHS-N10XA
$16.0 < Q \leq 25.2\text{kW}$ $(54 < Q \leq 86\text{kBtu/h})$ $(4.77 < Q \leq 7.16\text{RT})$	
$25.2 < Q \leq 28.0\text{kW}$ $(86 < Q \leq 96\text{kBtu/h})$ $(7.16 < Q \leq 8\text{RT})$	

*1: Refer to the installation and maintenance manual for the outdoor unit for the following piping size.

- Upstream piping of Switch Box
- Downstream piping of Switch Box when the branch is located downstream of Switch Box.

*2: Refer to Section 8.1 for the flaring work.

NOTE:

The accessory numbers are listed in Table 7.1.

(4) Piping Insulation

Unit: mm(inch)

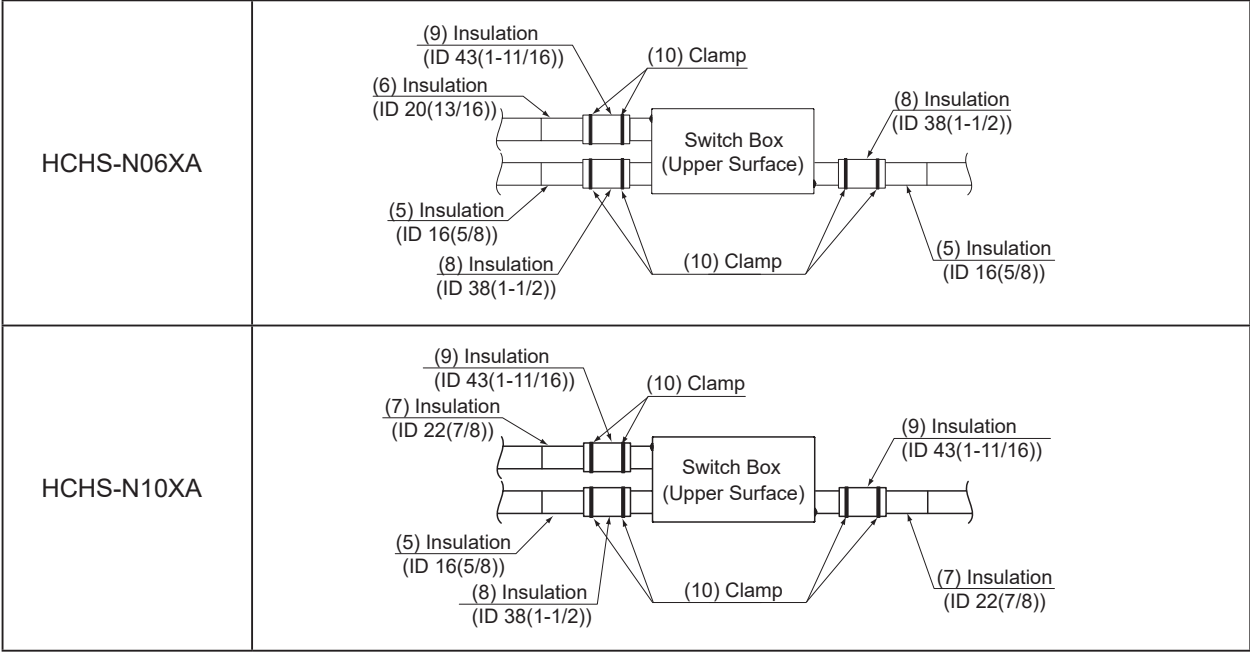

NOTES:

1. The accessory numbers are listed in Table 7.1.
2. When the humidity inside the ceiling is high, apply additional insulation to the flare nut connection.

■ HCHM-N(04-16)XA

Provide the refrigerant pipe in the field.

Make sure that the refrigerant pipe is connected to the same refrigerant cycle unit.

(1) Position of Piping Connection

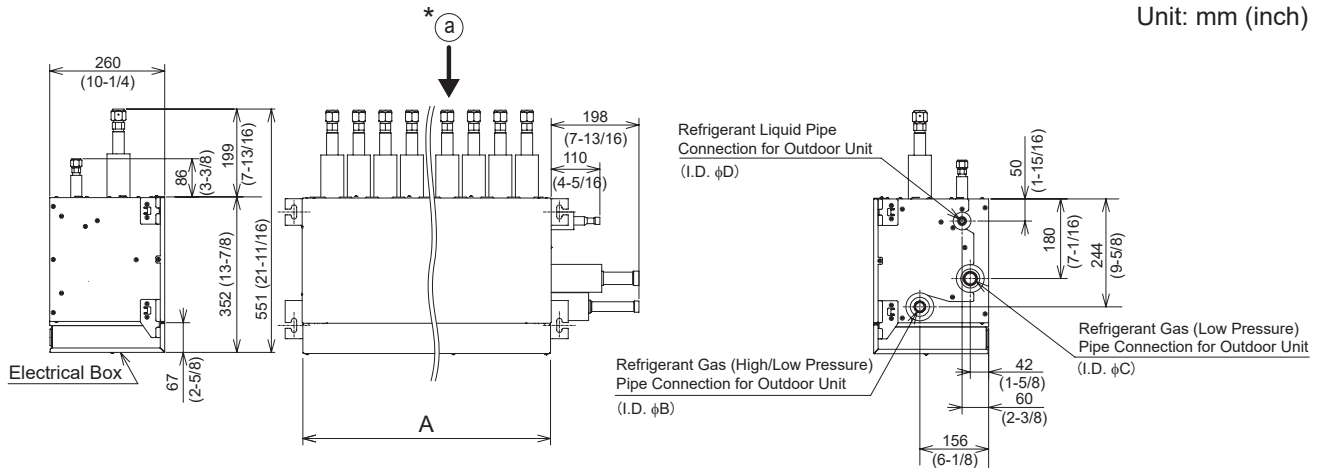

Model	Dimension A	Dimension B	Dimension C	Dimension D
HCHM-N04XA	303 (11-15/16)	22.2 (7/8)	25.4 (1)	12.7 (1/2)
HCHM-N08XA	543 (21-3/8)	22.2 (7/8)	28.6 (1 1/8)	12.7 (1/2)
HCHM-N12XA	783 (30-13/16)	25.4 (1)	28.6 (1 1/8)	15.88 (5/8)
HCHM-N16XA	1023 (40-9/32)	28.6 (1-1/8)	31.75 (1-1/4)	19.05 (3/4)

View of Indoor Unit Connecting Side ^{*}a

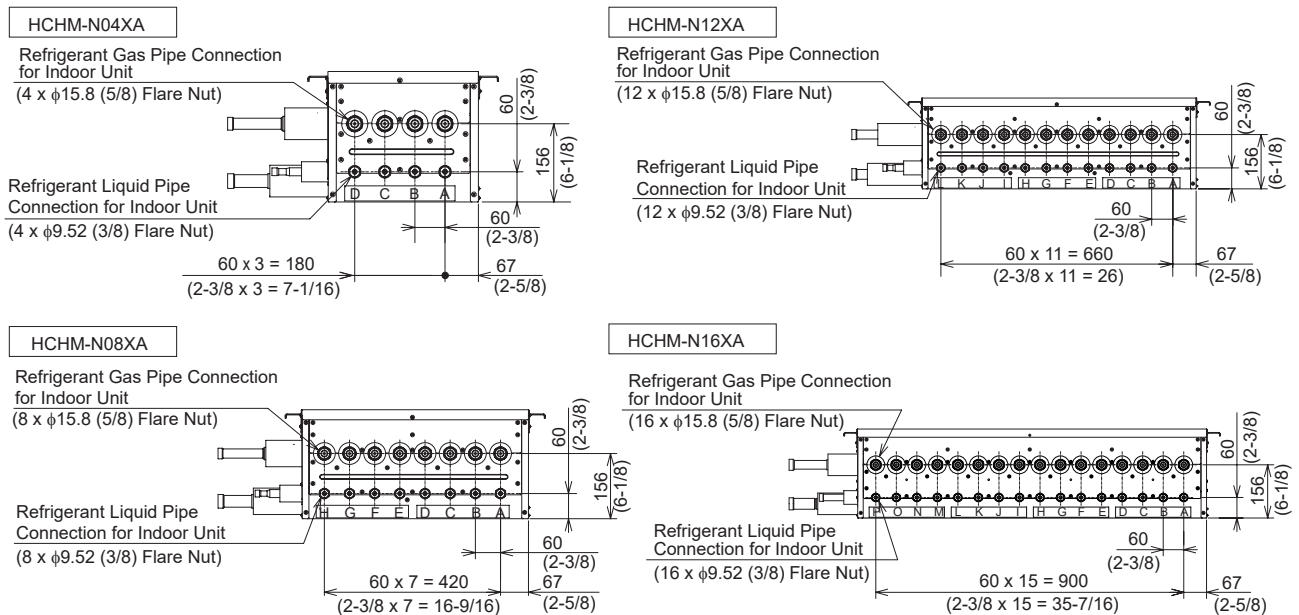

(2) Piping Work for Switch Box

Refrigerant piping size depends on the combinations with the outdoor unit. Refer to the installation and maintenance manual for the outdoor unit. Perform piping work for the Switch Box according to the following figure.

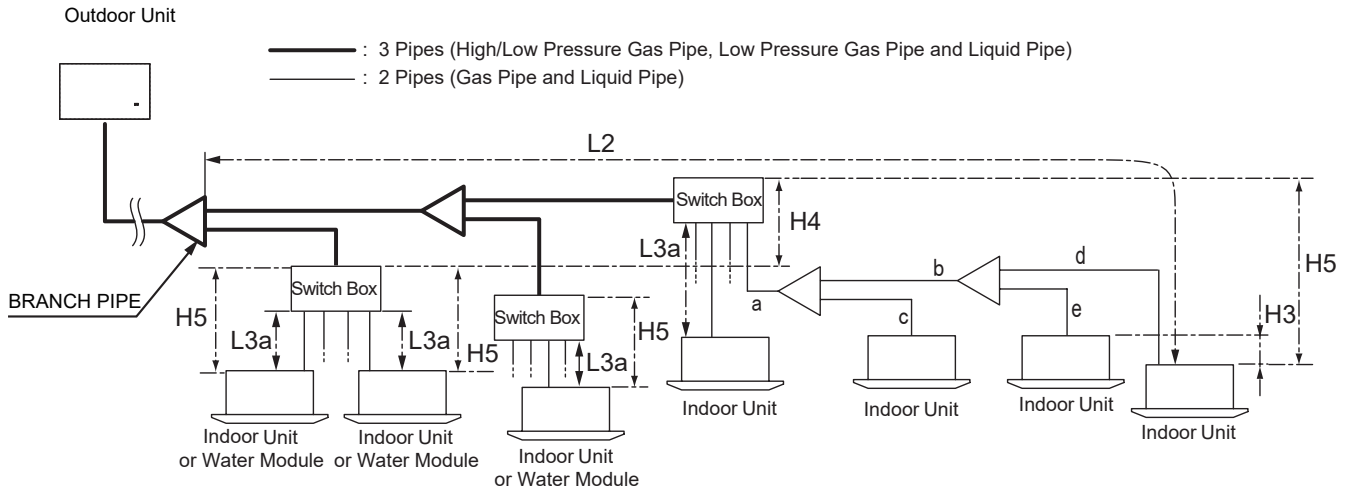

Item		Mark	Allowable Piping Length
Piping Length	Maximum Piping Length between BRANCH PIPE of 1st Branch and Terminal Indoor Unit	L2	≤ 90m (295 ft) ¹
	Maximum Piping Length between Switch Box and Indoor Unit	L3a, a+b+d, a+b+e or a+c	≤ 40m (131 ft) ²
	In Case there is Branch after Switch Box, Total Piping Length from Switch Box to Each Connected Indoor Unit per Branch	a+b+c+d+e	≤ 40m (131 ft)
Height Difference	In Case there is Branch after Switch Box, Height Difference between Indoor Units Connected to Same Connection Port of Switch Box	H3	< 4m (13 ft)
	Height Difference between Switch Boxes	H4	< 15m (49 ft)
	Height Difference between Switch Box and Indoor Unit	H5	Refer to NOTE 3.

NOTES:

1. When the piping length from the first branch to the terminal indoor unit exceeds 40m (131 ft), there are restrictions. Refer to the installation and maintenance manual for the outdoor unit.
2. If the piping length (L3a) between each Switch Box and indoor unit is considerably longer than other indoor unit, refrigerant may not flow well, and may lessen the unit's performance compared to other models. (Recommended Piping Length: Within 15m (49 ft))
3. When the height difference between Switch Box and indoor unit is long, the performance may decrease. (Recommended Piping Length: Within 15m (49 ft))
4. Each Water Module must occupy one branch of Switch Box exclusively.

(3) Selecting Piping Size

- Select the size for the high/low pressure gas pipe, low pressure gas pipe and liquid pipe according to Table 8.3. The size depends on the indoor unit total capacity connected downstream of the Switch Box.
- As for the BRANCH PIPE branch or header branch, refer to the Technical Catalog for the Outdoor Unit.
- Perform the piping connection work for the Switch Box as shown below.

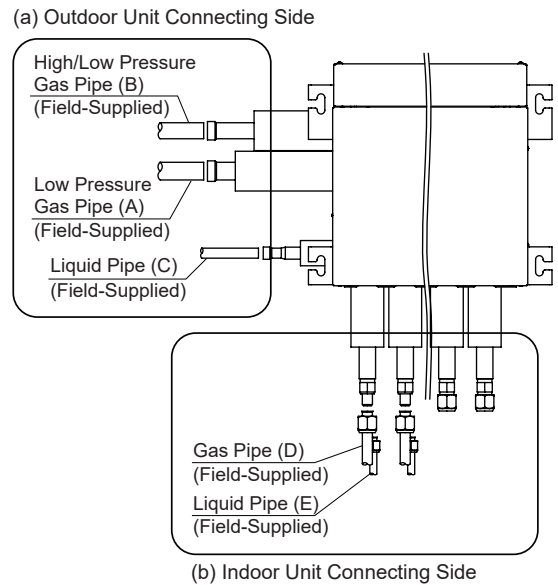

(a) Outdoor Unit Side Field Piping Size

Table 8.3 Outdoor Unit Side Field Piping Size

Connected Indoor Unit Capacity: Q	Low Pressure Gas Pipe (A) mm (inch)	High/Low Pressure Gas Pipe (B) mm (inch)	Liquid Pipe (C) mm (inch)
Q < 16.0kW (Q<54kBtu/h) (Q<4.77RT)	φ15.88 (5/8)	φ12.7 (1/2)	φ9.52 (3/8)
16.0 ≤ Q < 25.2kW (54 ≤ Q < 86kBtu/h) (4.77 ≤ Q < 7.16RT)	φ19.05 (3/4)	φ15.88 (5/8)	φ9.52 (3/8)
25.2 ≤ Q < 33.5kW (86 ≤ Q < 114kBtu/h) (7.16 ≤ Q < 9.52RT)	φ22.2 (7/8)	φ19.05 (3/4)	φ9.52 (3/8)
33.5 ≤ Q < 44.8kW (114 ≤ Q < 154kBtu/h) (9.52 ≤ Q < 12.73RT)	φ25.4 (1)	φ22.2 (7/8)	φ12.7 (1/2)
44.8 ≤ Q < 50.0kW (154 ≤ Q < 172kBtu/h) (12.73 ≤ Q < 14.20RT)	φ28.58 (1-1/8)	φ22.2 (7/8)	φ12.7 (1/2)
50.0 ≤ Q < 61.5kW (172 ≤ Q < 210kBtu/h) (14.20 ≤ Q < 17.47RT)	φ28.58 (1-1/8)	φ22.2 (7/8)	φ15.88 (5/8)
61.5 ≤ Q < 73.0kW (210 ≤ Q < 250kBtu/h) (17.47 ≤ Q < 20.74RT)	φ28.58 (1-1/8)	φ25.4 (1)	φ15.88 (5/8)
73.0 ≤ Q ≤ 85.0kW (250 ≤ Q ≤ 290kBtu/h) (20.74 ≤ Q ≤ 24.14RT)	φ31.75 (1-1/4)	φ28.58 (1-1/8)	φ19.05 (3/4)

NOTE:

Refer to “Position of Piping Connection” for the details of the piping connection for the Switch Box. Use field-supplied reducer in case the field piping and Switch Box piping connection does not match.

Details of changes to the piping size for connection to the Switch Box are shown below.

HCHM-N04XA

Unit: mm (inch)

	Piping Connection Size for Switch Box	Required Pipe Size	Field-Supplied	Remarks
Low Pressure Gas Pipe (A)	φ25.4 (1)	φ19.05 (3/4)	OD25.4 (1) → ID19.05 (3/4)	Apply Field-Supplied Reducer (2 Size Down)
		φ22.2 (7/8)	OD25.4 (1) → ID22.2 (7/8)	Apply Field-Supplied Reducer
		φ25.4 (1)	-	-
		φ28.58 (1-1/8)	OD25.4 (1) → ID28.58 (1-1/8)	Apply Field-Supplied Reducer
High/Low Pressure Gas Pipe (B)	φ22.2 (7/8)	φ12.7 (1/2)	OD22.2 (7/8) → ID12.7 (1/2)	Apply Field-Supplied Reducer (3 Size Down)
		φ15.88 (5/8)	OD22.2 (7/8) → ID15.88 (5/8)	Apply Field-Supplied Reducer (2 Size Down)
		φ19.05 (3/4)	OD22.2 (7/8) → ID19.05 (3/4)	Apply Field-Supplied Reducer
		φ22.2 (7/8)	-	-
Liquid Pipe (C)	φ12.7 (1/2)	φ9.52 (3/8)	OD12.7 (1/2) → ID9.52 (3/8)	Apply Field-Supplied Reducer
		φ12.7 (1/2)	-	-

HCHM-N08XA

Unit: mm (inch)

	Piping Connection Size for Switch Box	Required Pipe Size	Field-Supplied	Remarks
Low Pressure Gas Pipe (A)	φ28.58 (1-1/8)	φ19.05 (3/4)	OD28.58 (1-1/8) → ID19.05 (3/4)	Apply Field-Supplied Reducer (3 Size Down)
		φ22.2 (7/8)	OD28.58 (1-1/8) → ID22.2 (7/8)	Apply Field-Supplied Reducer (2 Size Down)
		φ25.4 (1)	OD28.58 (1-1/8) → ID25.4 (1)	Apply Field-Supplied Reducer
		φ28.58 (1-1/8)	-	-
		φ34.93 (1-3/8)	OD28.58 (1-1/8) → ID34.93 (1-3/8)	Apply Field-Supplied Reducer
High/Low Pressure Gas Pipe (B)	φ22.2 (7/8)	φ15.88 (5/8)	OD22.2 (7/8) → ID15.88 (5/8)	Apply Field-Supplied Reducer (2 Size Down)
		φ19.05 (3/4)	OD22.2 (7/8) → ID19.05 (3/4)	Apply Field-Supplied Reducer
		φ22.2 (7/8)	-	-
		φ25.4 (1)	OD22.2 (7/8) → ID25.4 (1)	Apply Field-Supplied Reducer
		φ28.58 (1-1/8)	OD22.2 (7/8) → ID28.58 (1-1/8)	Apply Field-Supplied Reducer (2 Size Up)
Liquid Pipe (C)	φ12.7 (1/2)	φ9.52 (3/8)	OD12.7 (1/2) → ID9.52 (3/8)	Apply Field-Supplied Reducer
		φ12.7 (1/2)	-	-
		φ15.88 (5/8)	OD12.7 (1/2) → ID15.88 (5/8)	Apply Field-Supplied Reducer
		φ19.05 (3/4)	OD12.7 (1/2) → ID19.05 (3/4)	Apply Field-Supplied Reducer (2 Size Up)

HCHM-N12XA

Unit: mm (inch)

	Piping Connection Size for Switch Box	Required Pipe Size	Field-Supplied	Remarks
Low Pressure Gas Pipe (A)	φ28.58 (1-1/8)	φ22.2 (7/8)	OD28.58 (1-1/8) → ID22.2 (7/8)	Apply Field-Supplied Reducer (2 Size Down)
		φ25.4 (1)	OD28.58 (1-1/8) → ID25.4 (1)	Apply Field-Supplied Reducer
		φ28.58 (1-1/8)	-	-
		φ34.93 (1-3/8)	OD28.58 (1-1/8) → ID34.93 (1-3/8)	Apply Field-Supplied Reducer
High/Low Pressure Gas Pipe (B)	φ25.4 (1)	φ19.05 (3/4)	OD25.4 (1) → ID19.05 (3/4)	Apply Field-Supplied Reducer (2 Size Down)
		φ22.2 (7/8)	OD25.4 (1) → ID22.2 (7/8)	Apply Field-Supplied Reducer
		φ25.4 (1)	-	-
		φ28.58 (1-1/8)	OD25.4 (1) → ID28.58 (1-1/8)	Apply Field-Supplied Reducer
Liquid Pipe (C)	φ15.88 (5/8)	φ9.52 (3/8)	OD15.88 (5/8) → ID9.52 (3/8)	Apply Field-Supplied Reducer (2 Size Down)
		φ12.7 (1/2)	OD15.88 (5/8) → ID12.7 (1/2)	Apply Field-Supplied Reducer
		φ15.88 (5/8)	-	-
		φ19.05 (3/4)	OD15.88 (5/8) → ID19.05 (3/4)	Apply Field-Supplied Reducer

HCHM-N16XA

Unit: mm (inch)

	Piping Connection Size for Switch Box	Required Pipe Size	Field-Supplied	Remarks
Low Pressure Gas Pipe (A)	φ31.75 (1-1/4)	φ22.2 (7/8)	OD31.75 (1-1/4) → ID22.2 (7/8)	Apply Field-Supplied Reducer (3 Size Down)
		φ25.4 (1)	OD31.75 (1-1/4) → ID25.4 (1)	Apply Field-Supplied Reducer (2 Size Down)
		φ28.58 (1-1/8)	OD31.75 (1-1/4) → ID28.58 (1-1/8)	Apply Field-Supplied Reducer
		φ31.75 (1-1/4)	-	-
High/Low Pressure Gas Pipe (B)	φ28.58 (1-1/8)	φ19.05 (3/4)	OD28.58 (1-1/8) → ID19.05 (3/4)	Apply Field-Supplied Reducer (3 Size Down)
		φ22.2 (7/8)	OD28.58 (1-1/8) → ID22.2 (7/8)	Apply Field-Supplied Reducer (2 Size Down)
		φ25.4 (1)	OD28.58 (1-1/8) → ID25.4 (1)	Apply Field-Supplied Reducer
		φ28.58 (1-1/8)	-	-
Liquid Pipe (C)	φ19.05 (3/4)	φ9.52 (3/8)	OD19.05 (3/4) → ID9.52 (3/8)	Apply Field-Supplied Reducer (3 Size Down)
		φ12.7 (1/2)	OD19.05 (3/4) → ID12.7 (1/2)	Apply Field-Supplied Reducer (2 Size Down)
		φ15.88 (5/8)	OD19.05 (3/4) → ID15.88 (5/8)	Apply Field-Supplied Reducer
		φ19.05 (3/4)	-	-

(b) Indoor Unit Side Field Piping Size

- When a branch is located downstream of the Switch Box

Connected Indoor Unit Capacity: (Q)	Gas Pipe (D)	Liquid Pipe (E)
	mm (inch)	mm (inch)
Q < 16.0kW (Q < 54kBtu/h) (Q < 4.77RT)	φ15.88 (5/8) ¹	φ9.52 (3/8) ¹
Q = 16.0kW (Q = 54kBtu/h) (Q = 4.77RT)	φ19.05 (3/4)	φ9.52 (3/8) ¹

1. Field flaring work is required. Refer to Section 8.3 for the flaring work.

- When a branch is not located downstream of the Switch Box

Connected Indoor Unit Capacity: (Q)	Gas Pipe (D)	Liquid Pipe (E)	Remarks
	inch (mm)	inch (mm)	
1.2 ≤ Q ≤ 6.3kW (4 ≤ Q ≤ 22kBtu/h) (0.34 ≤ Q ≤ 1.79RT)	φ12.7 (1/2)	φ6.35 (1/4)	Use accessory pipe (1) on gas pipe side and accessory pipe (2) on liquid pipe side to decrease the pipe size.
7.1 ≤ Q ≤ 16.0kW (24 ≤ Q ≤ 54kBtu/h) (2.02 ≤ Q ≤ 4.77RT)	φ15.88 (5/8) ¹	φ9.52 (3/8) ¹	-
Q = 22.4kW (Q = 76kBtu/h) (Q = 6RT)	φ19.05 (3/4)	φ9.52 (3/8) ¹	Use accessory pipe (3) on gas pipe side to increase the pipe size.
Q = 28.0kW (Q = 96kBtu/h) (Q = 8RT)	φ22.2 (7/8)	φ9.52 (3/8) ¹	Use accessory pipe (4) on gas pipe side to increase the pipe size.

1. Field flaring work is required. Refer to Section 8.3 for the flaring work.

NOTES:

1. When connecting the Gas Pipe (D) and Liquid Pipe (E), reuse the flare nut attached to the Switch Box.
2. When the connected indoor unit capacity is 1.2~6.3kW(4~22kBtu/h, 0.34~1.79RT) and the piping length exceeds 15m (49ft.), use 9.52mm (3/8 inch) for the liquid pipe.

NOTICE

In case the piping connection is not used for the indoor unit side piping connection, it must be sealed using the closed flare nut originally attached. These flare nuts have been tightened by torque specifications shown below before shipping. Ensure that they are sealed completely.

- Tightening Torque for Flare Nut before shipping

Item	Tightening Torque
Gas Pipe Flare Nut	75±7 N·m (55.3±5 ft·lbs)
Liquid Pipe Flare Nut	38±4 N·m (28.0±3 ft·lbs)

NOTICE

1. In case of 8HP (22.4kW, 72kBtu/h, 6RT) and 10HP (28kW, 96kBtu/h, 8RT) type indoor unit connection: Up to two 8HP (22.4kW, 72kBtu/h, 6RT) and 10HP (28kW, 96kBtu/h, 8RT) type indoor units can be connected to the Switch Box within the “Maximum Total Capacity of All Connected Indoor Units”. Make sure to increase the pipe connection size by using the appropriate accessory pipe.
2. In case of 8HP (22.4kW, 72kBtu/h, 6RT) and 10HP (28kW, 96kBtu/h, 8RT) type indoor unit connection: Only single unit per branch is allowed to be connected.
3. In case the number of indoor unit connection is less and the piping connections are left over:
 - Unused piping connections must be sealed using the closed flare nut originally attached. It is unnecessary to attach closed-end piping. Refrigerant leakage is caused by loosened flare nuts. Ensure that they are sealed completely. Use specified tightening torque according to the table “Tightening Torque for Flare Nut before shipping” above.
 - Any piping connections can be left over.
4. In case there is plan for additional indoor units in the future:
 - Do not plan the piping size for additional indoor units. Ensure to select the piping again in the future.
 - Additional indoor units can be connected only after the refrigerant is recovered.

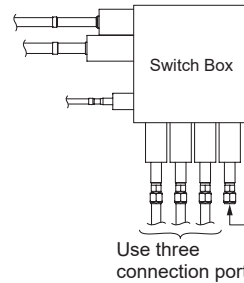

Example; In case one of the piping connection is unused, ensure the closed flare nut originally attached is secured. (For gas and liquid sides)

Above figure illustrate the example of HCHM-N04XA.

(4) Piping Insulation

- (a) After the air-tight leakage test, perform insulation work as shown below.

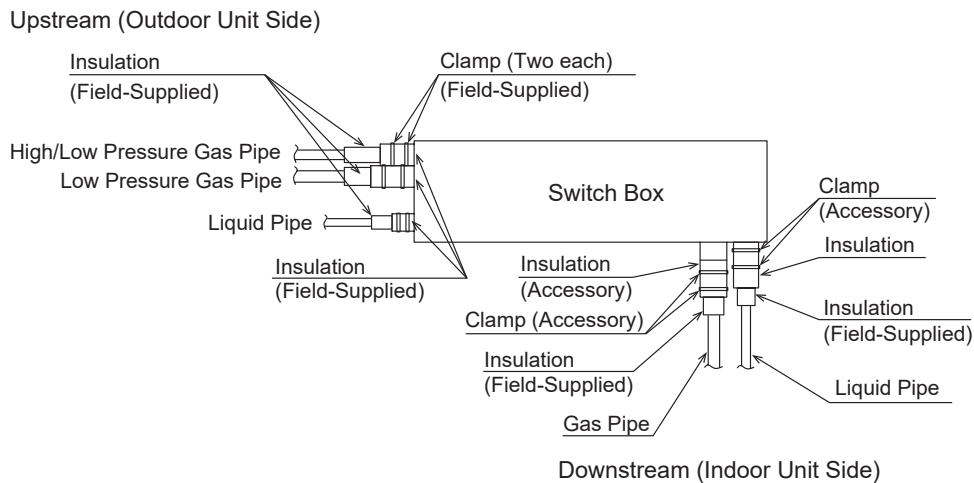

- (b) Insulate gas and liquid pipe separately using the accessory insulation material.
In the event that temperature and humidity levels inside the ceiling exceed 30°C (86°F)/RH, relative humidity 80%, apply additional insulation materials (approximately 10mm (3/8 inch) thickness) to the surface of the accessory insulation material to avoid condensation.
- (c) Perform cold insulation work by insulating and taping the flare connection and reducer connection.
Also insulate all the refrigerant pipes.

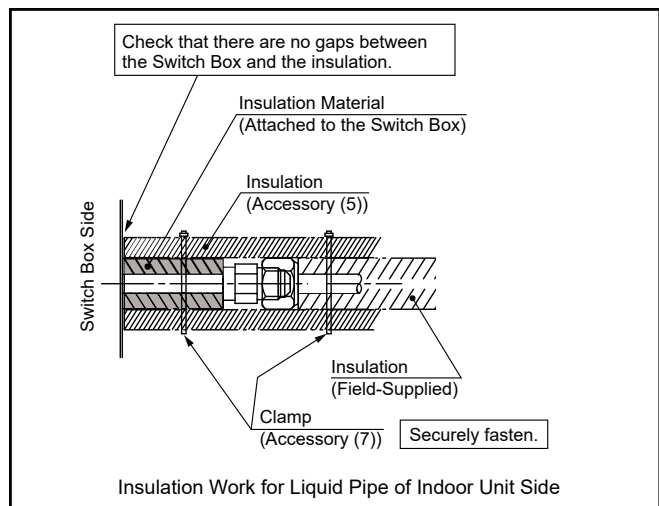
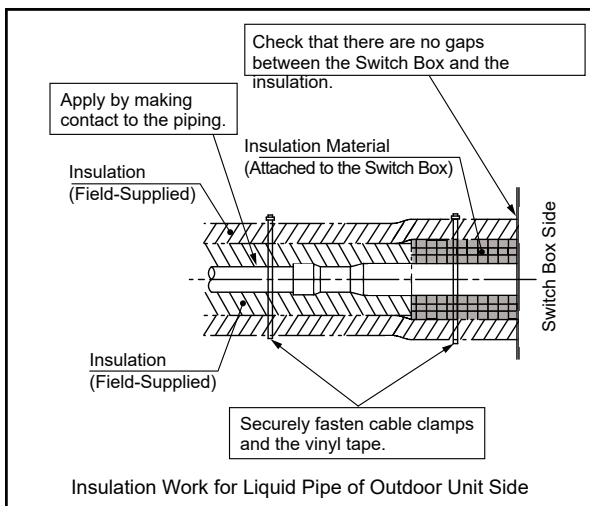
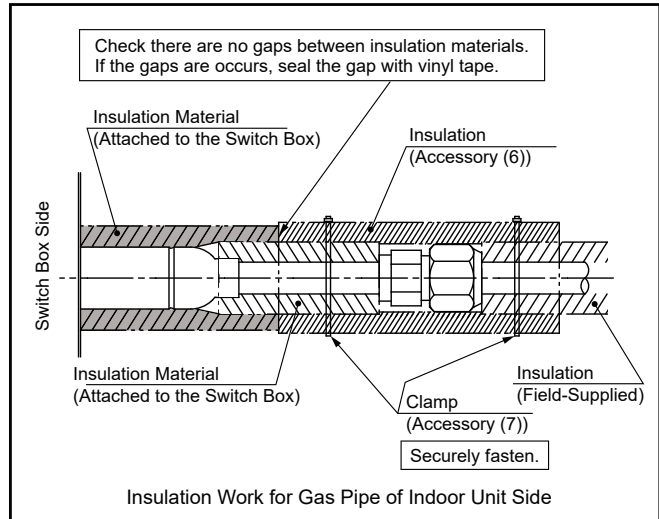
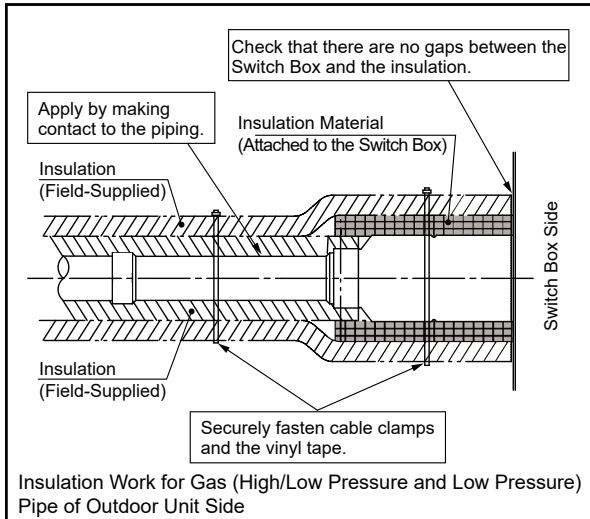

- (d) In case there are unused piping connection, ensure to apply accessory insulation material to the piping and flare connections without gaps as shown on the right figure (For gas and liquid sides)

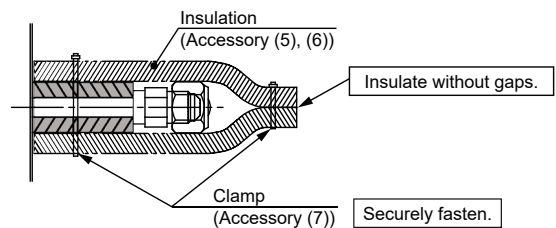

9. Test Run

NOTICE

Refrigerant piping and connecting wires should be connected to the same refrigeration cycle system. If they are connected to the dissimilar refrigeration cycle systems, a malfunction may occur.

WARNING

- **Special Attention Regarding Refrigerant Gas Leakage**

The refrigerant R410A is non-toxic and inflammable in its original state.

However, in consideration of a state where the refrigerant leaks into the room, measures against refrigerant leaks must be taken in small rooms where the tolerable level could be exceeded.

Take countermeasures by installing ventilation devices, etc.

< Calculation of Refrigerant Concentration >

- (1) Calculate the total quantity of refrigerant R (kg) charged in the system connecting all the indoor units of rooms to be air-conditioned.
- (2) Calculate the room Volume V (m³) of each room.
- (3) Calculate the refrigerant concentration C (kg/m³) of the room according to the following equation.

$$\frac{R: \text{Total Quantity of Charged Refrigerant (kg)}}{V: \text{Room Volume (m}^3\text{)}} = C: \text{Refrigerant Concentration} \leq 0.42 \text{ (kg/m}^3\text{) for R410A}$$

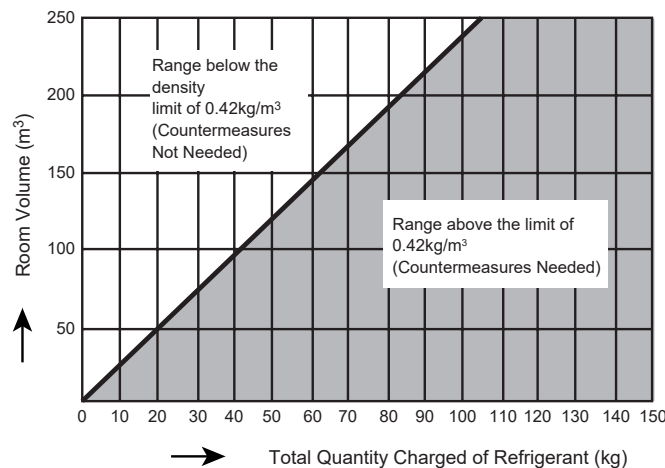

Perform a test run according to the “Installation and Maintenance Manual” of the outdoor unit.

WARNING

- **Do not operate the system until all the check points are cleared.**
 - (A) Check to ensure that the electrical resistance is more than 1 megohm by measuring the resistance between ground and the terminal block in the electrical box. If not, do not operate the system until the electric leakage is located and repaired.
 - (B) Check to ensure that the stop valves of the outdoor unit are fully opened, and then start the system.
 - (C) Apply power to the outdoor unit(s) at least 12 hours prior to operation of the system for preheating of the compressor oil.
- **Pay attention to the following items while the system is running.**
 - (A) Do not touch any of the parts by hand at the discharge gas side, since the compressor chamber and the pipes at the discharge side are heated higher than 90°C (194°F).

10. Alarm code

PCB1 of single branch type Switch Box

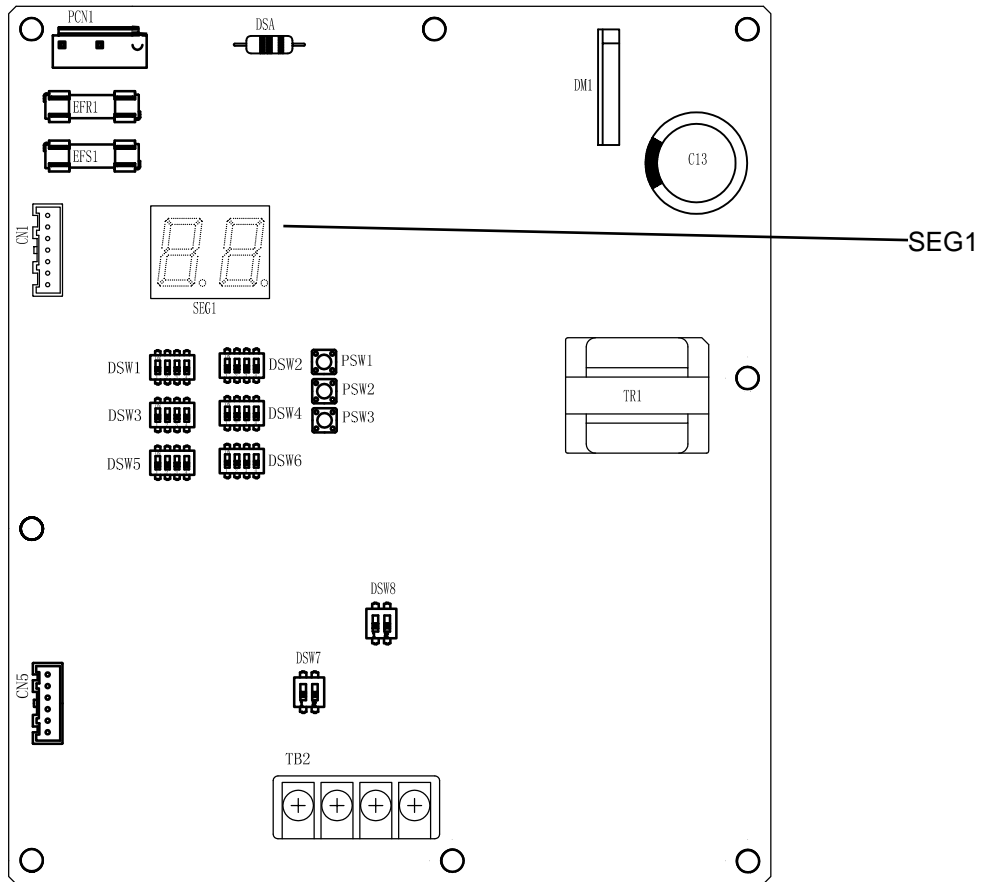

PCB1-3 of multiple branch type Switch Box

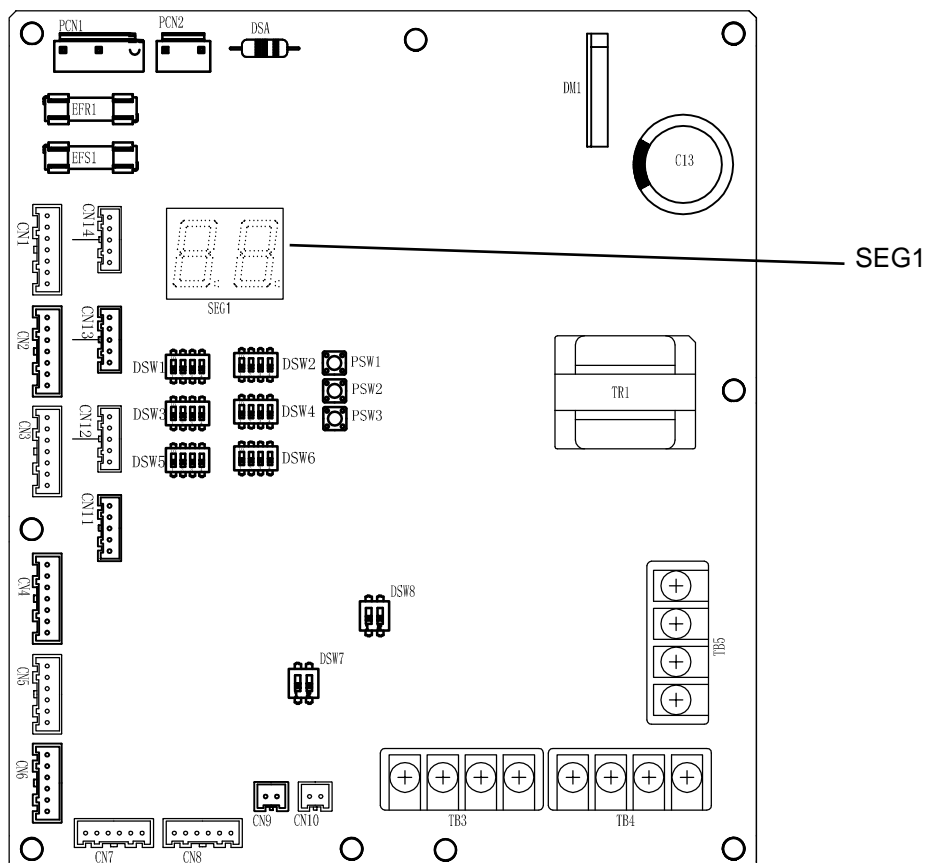

Check Mode

Press PSW2 in normal mode for more than 3 seconds to enter check mode. Data of each item displays Interactively in check mode. Press PSW2 for "forward" and PSW3 for "backward".

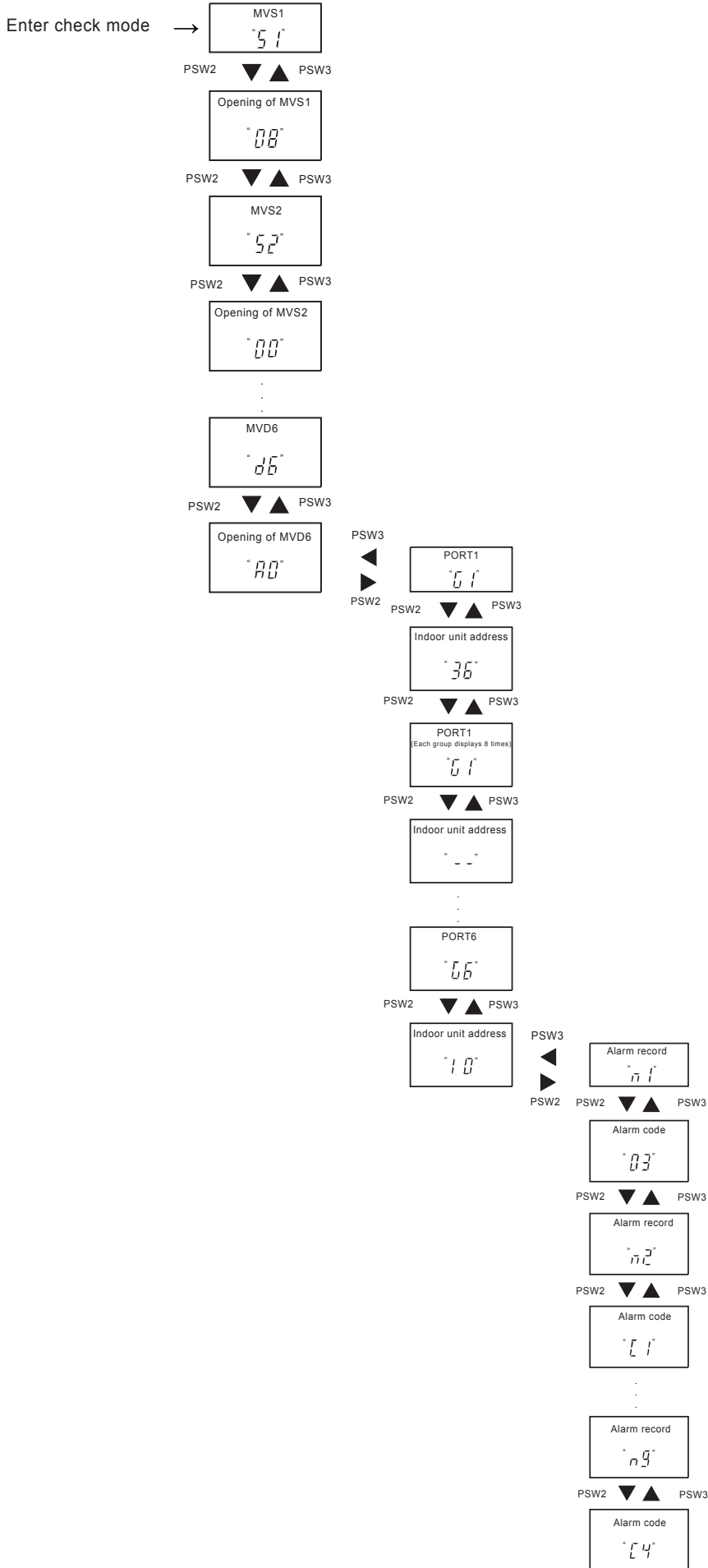

Indications by 7-segment display on Switch Box PCB:

Display	Expansion valve		Display content
	Single branch type	Multiple branch type	
51	MVS1	MVS1	00: Fully Close 80: Fully Open 88: 8%(Bypass)
52	-	MVS2	
53	-	MVS3	
54	-	MVS4	
55	-	MVS5	
56	-	MVS6	
81	MVD1	MVD1	
82	-	MVD2	
83	-	MVD3	
84	-	MVD4	
85	-	MVD5	
86	-	MVD6	

Display	PORT		Display content
	Single branch type	Multiple branch type	
61	PORT1	PORT1	36: 36, an example of indoor unit address number (from 0 to 63). 33: no indoor unit
62	-	PORT2	
63	-	PORT3	
64	-	PORT4	
65	-	PORT5	
66	-	PORT6	

Display	Alarm record		Display content
	Single branch type	Multiple branch type	
81	Alarm record n1 (latest) ~ Alarm record n9 (earliest)		Alarm codes refer to the table below.
82			
83			
84			
85			
86			
87			
88			
89			

Alarm code

The alarm code is indicated by 7-segment display on Switch Box PCB:

Display	Alarm Code	Content of abnormality
03	03	Abnormal transmission between Switch Box and outdoor unit. Abnormal transmission between Switch Box and indoor unit.
01	C1	There are 2 or more Switch Boxes connected seriesly between the outdoor and indoor units.
02	C2	There are 9 or more indoor units connected to one branch of Switch Box. There are 37 or more indoor units connected to one Switch Box PCB.
04	C4	Indoor units are deceted when the port is set as no-using by DSW2 or DSW3 refer to "Setting of DIP Switches" for the Switch Box HCHM-N04 ~ 16XA. No-using for the port is not set when no indoor unit is detected in the port.

11. Servicing

11.1 Removing Components for Switch Box



WARNING

TURN OFF all power source switches.

11.1.1 Removing Service Cover for Electrical Box and Electronic Expansion Valve

- (1) Remove the screws securing the electrical box cover and the electronic expansion valve cover.

HCHS-N06XA,HCHS-N10XA

Service Cover for Electrical Box: 2 screws

Service Cover for Electronic Expansion Valve: 2 screws

HCHM-N04XA

Service Cover for Electrical Box: 2 screws

Service Cover for Electronic Expansion Valve: 3 screws

HCHM-N08XA

Service Cover for Electrical Box: 3 screws

Service Cover for Electronic Expansion Valve: 3 screws

HCHM-N12XA

Service Cover for Electrical Box: 4 screws

Service Cover for Electronic Expansion Valve: 3 screws

HCHM-N16XA

Service Cover for Electrical Box: 4 screws

Service Cover for Electronic Expansion Valve: 3 screws

NOTE

When attaching / removing the service cover, take special care to avoid injury from the sharp edges.

Tool

Phillips Screwdriver

HCHS-N06XA,HCHS-N10XA

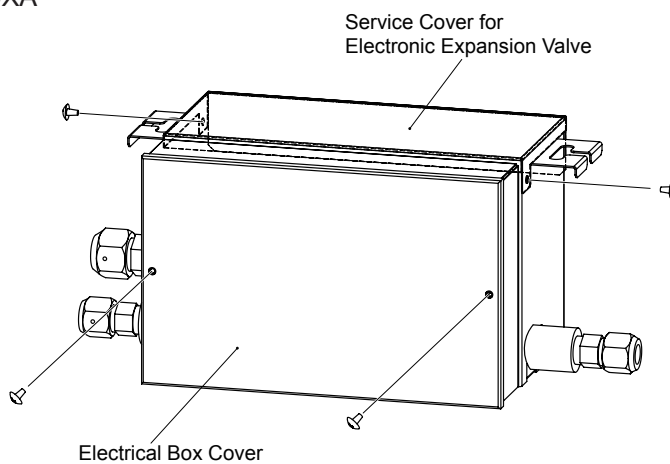

HCHM-N04XA

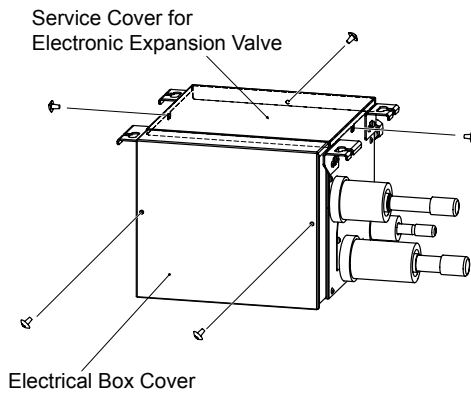

HCHM-N08XA

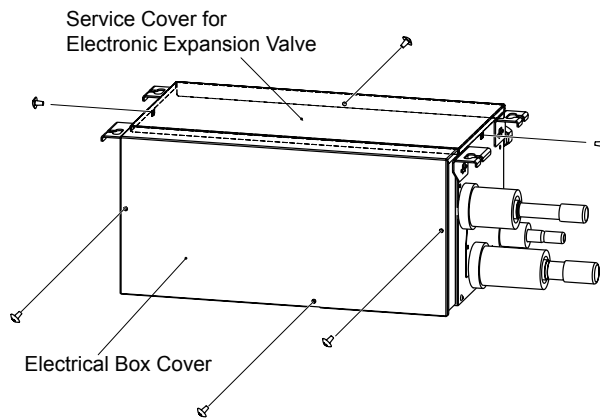

HCHM-N12XA

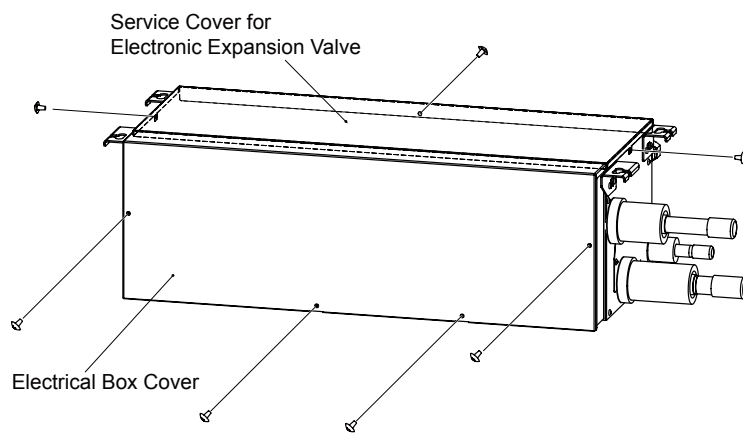

HCHM-N16XA

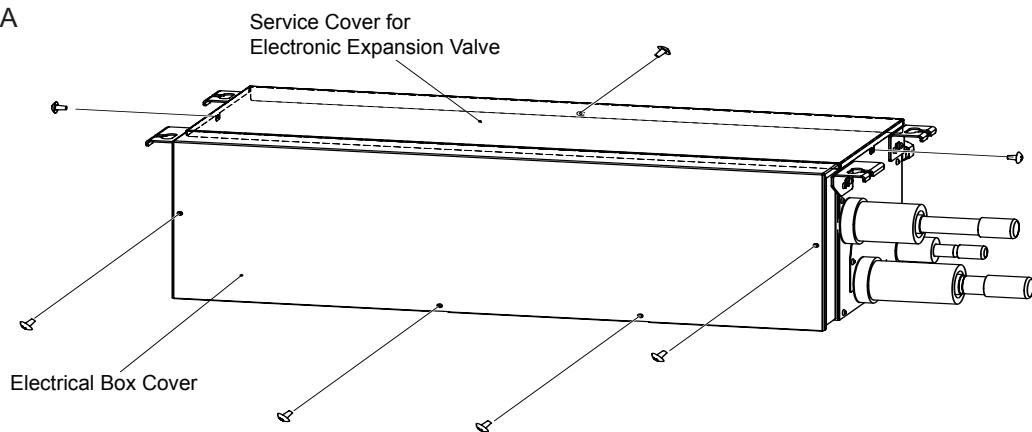

! WARNING

TURN OFF all power source switches.

11.1.2 Removing Electrical Components

Removing Switch Box PCB

- (1) Remove all the connectors for wiring connected to the Switch Box PCB.
- (2) Remove the communication wirings connected to the Switch Box PCB. Do not touch the electrical components on the Switch Box PCBs during the work. Otherwise, the Switch Box PCB may be damaged.
- (3) Hold the convex part of the holders securing the Switch Box PCB with a long nose pliers and pull it out to remove.

Removing Electrical Components (Terminal Block for Power Source)

HCHS-N06XA , HCHS-N10XA

- (1) Remove all the wirings connected to the electrical components.
- (2) Remove the screws securing the electrical components.

HCHM-N04XA, HCHM-N08XA, HCHM-N12XA, HCHM-N16XA

- (1) Remove all the wirings connected to the electrical components.
- (2) Remove the communication wirings connected to the Terminal Block (TB2).
- (3) Remove the screws securing the electrical components.

NOTE

When reassembling the electrical components, match the terminal numbers with the mark band numbers and also match the colors of the connectors on the Switch Box PCB with the colors of the connector for wiring. If they are incorrectly connected, malfunction may occur or the electrical components may be damaged.

Tool	Phillips Screwdriver, Long Nose Pliers, Wire Cutter
------	--

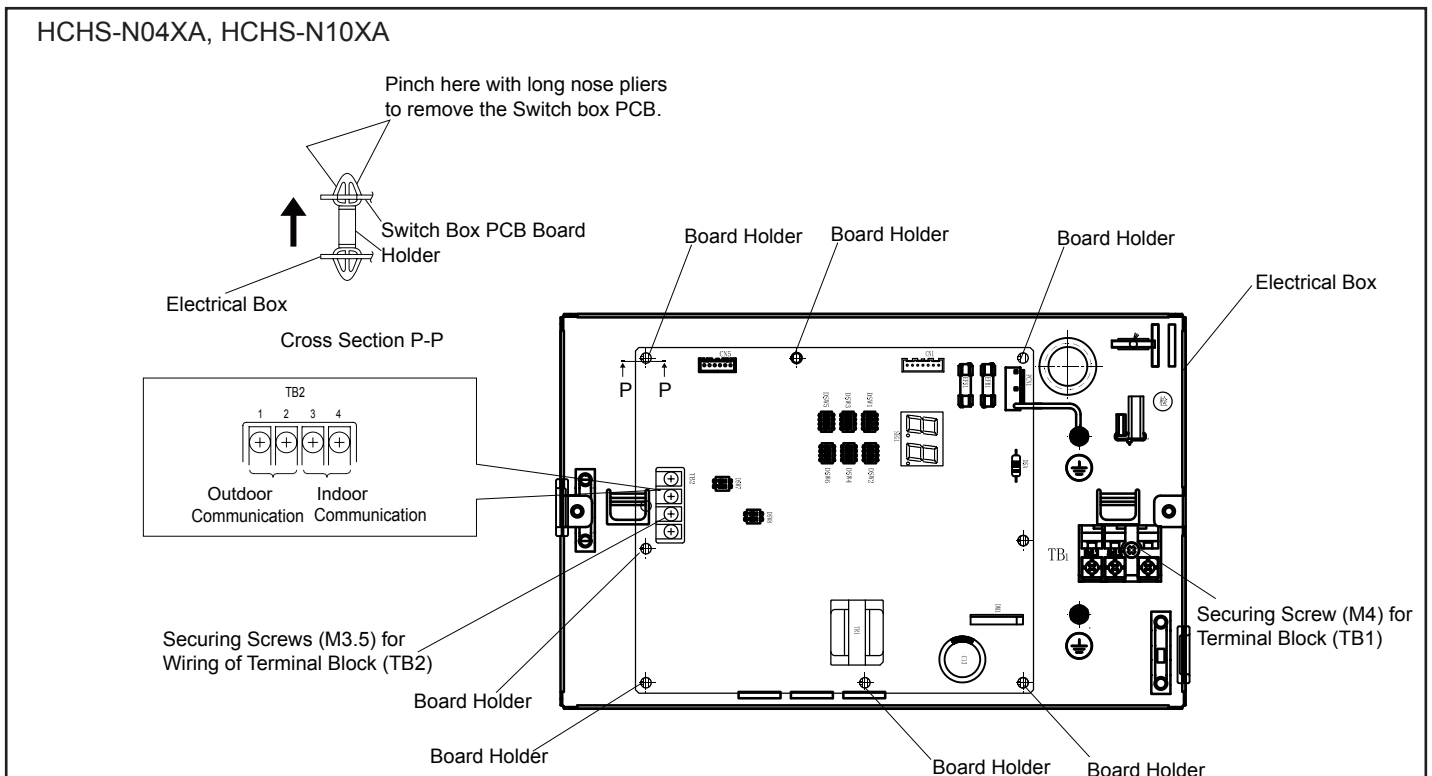

HCHM-N04XA

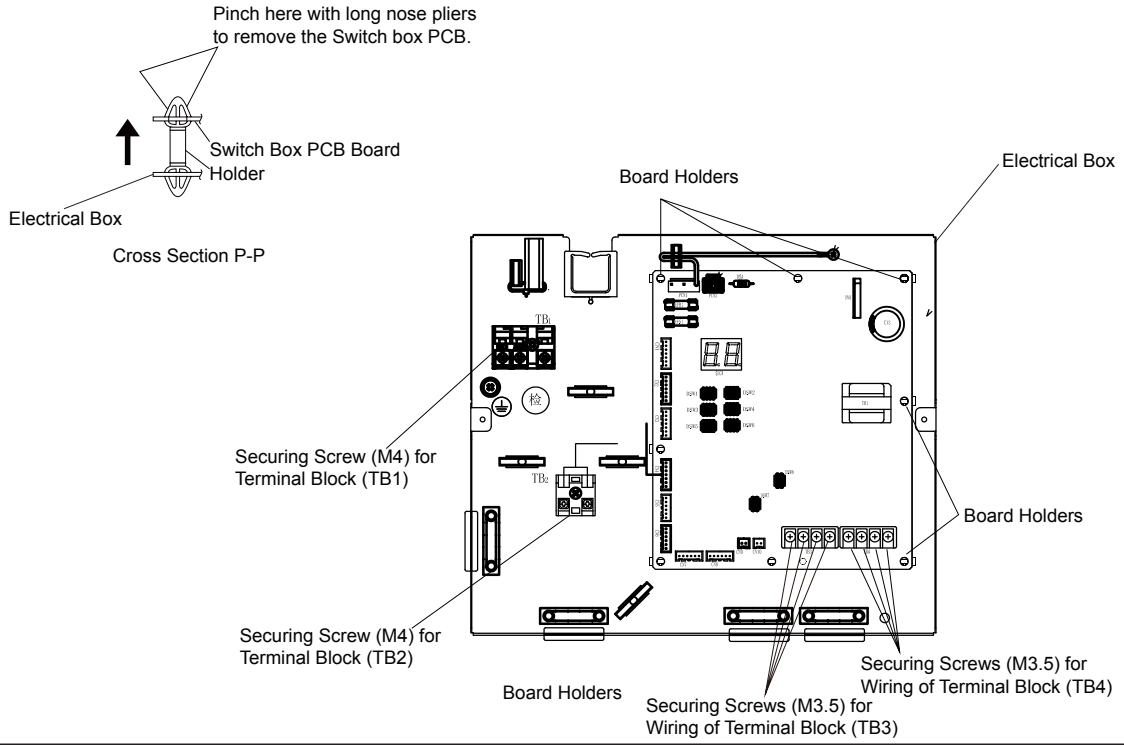

HCHM-N08XA

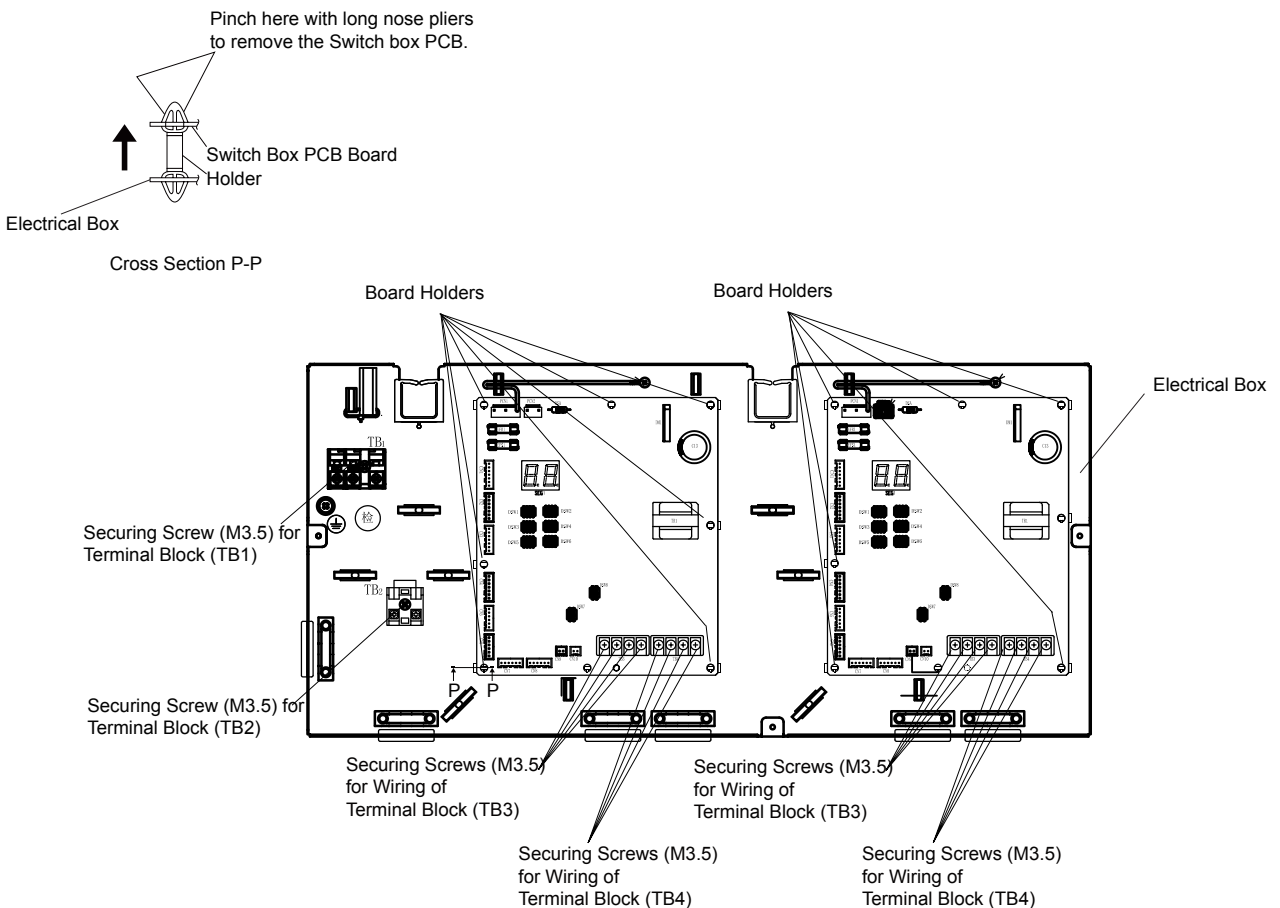

HCHM-N12XA

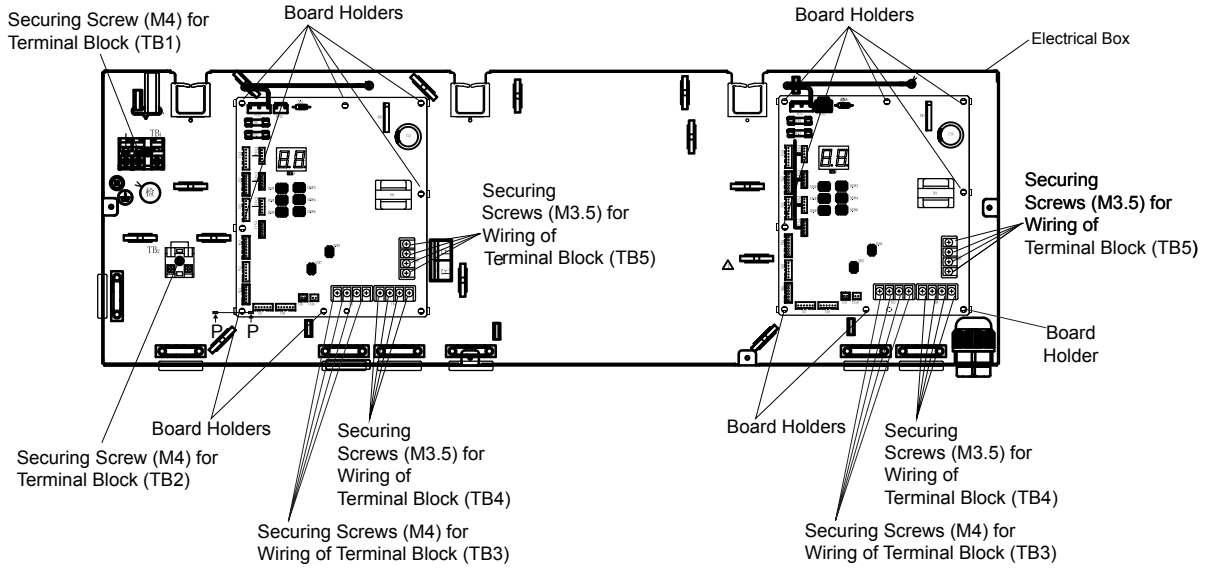
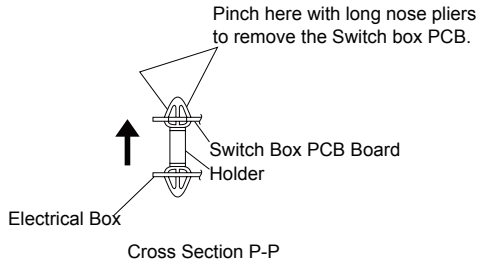

HCHM-N16XA

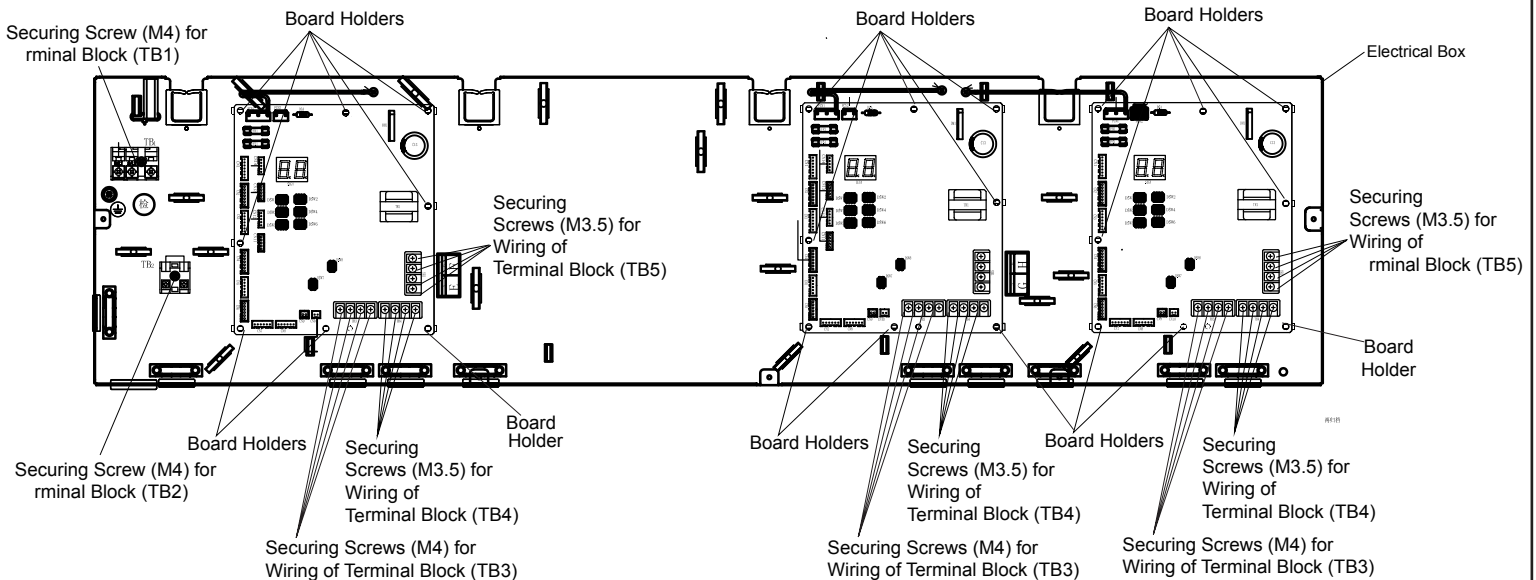
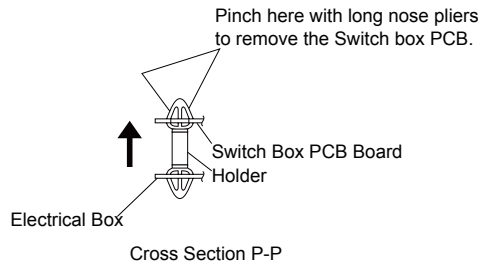

! WARNING

TURN OFF all power source switches.

11.1.3 Removing Electric Expansion Valve Coil

- (1) Remove the front service cover .
- (2) Removing Electronic Expansion Valve (MVD1~4, MVS1~4)
 - (a) Turn the electronic expansion valve coil. Remove the electronic expansion valve coil bracket from the electronic expansion valve slot. Then, pull the coil upward and remove it.
 - (b) When replacing the electronic expansion valve coil, turn the coil bracket and press the coil into the electronic expansion valve slot.

NOTE

- When replacing the electronic expansion valve, bind up the wirings with a cable band indicated in the figure. Make sure to bind up extra wirings and secure them with a wire clip. If not, water may enter the electrical box.
- When attaching Electronic Expansion Valve Coil to Electronic Expansion Valve, match the marking color in the table below.

HCHS-N06XA, HCHS-N10XA

Mark	Marking Color
MVS1	White
MVD1	Blue

HCHM-N04XA, HCHM-N08XA,
HCHM-N12XA, HCHM-N16XA

Mark	Marking Color
MVD1, MVS1	White
MVD2, MVS2	Red
MVD3, MVS3	Blue
MVD4, MVS4	Black

Tool	Wire Cutter
------	-------------

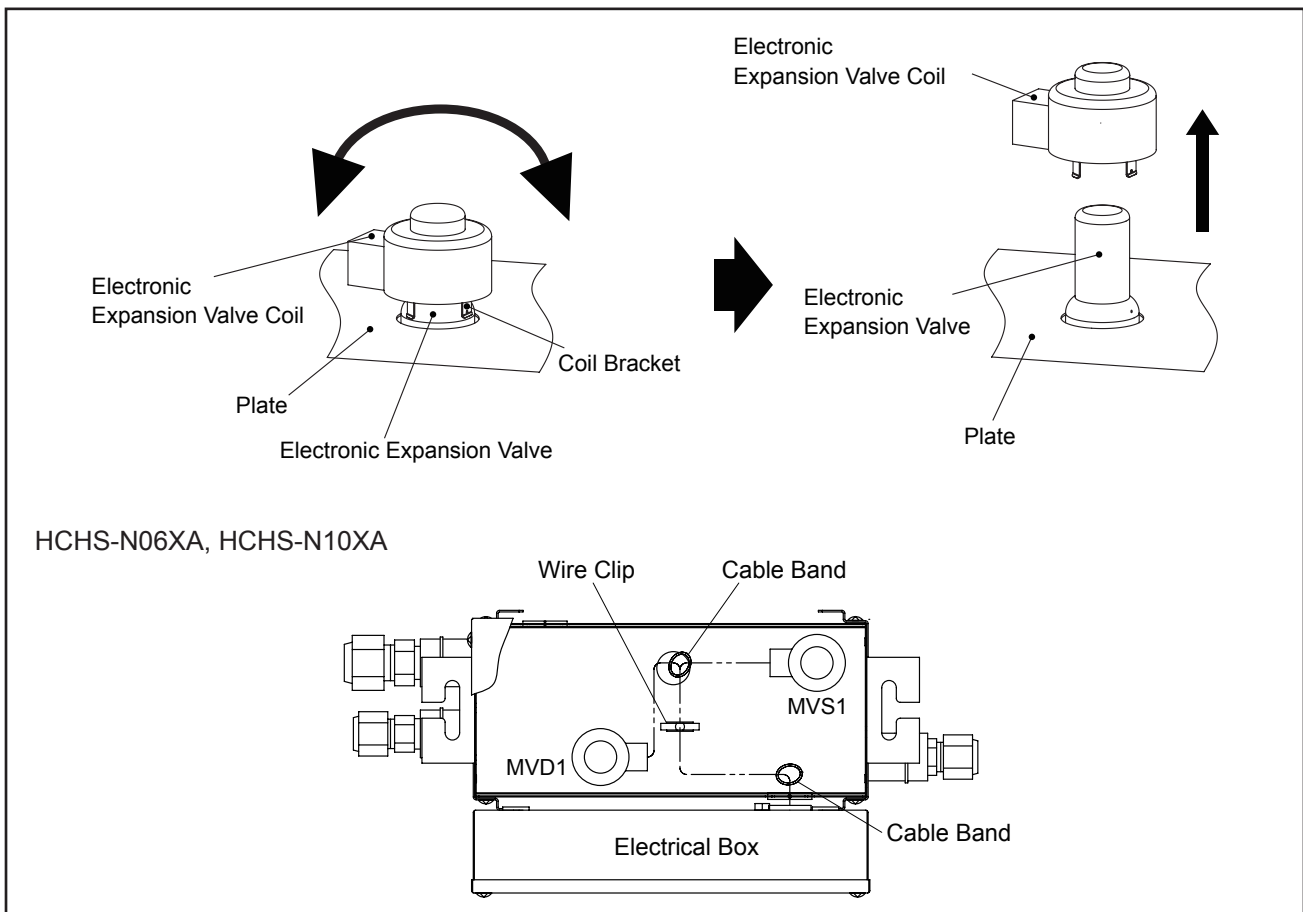

HCHM-N04XA

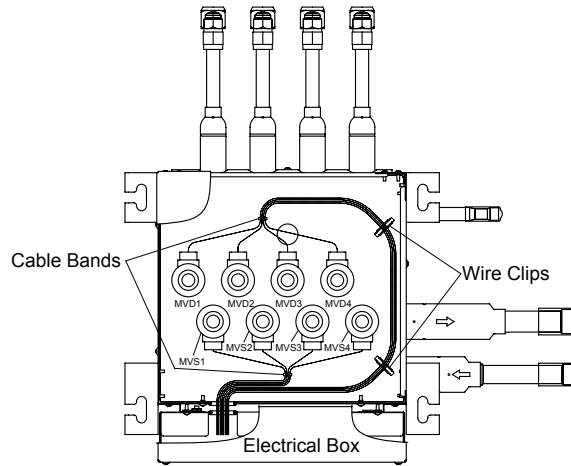

HCHM-N08XA

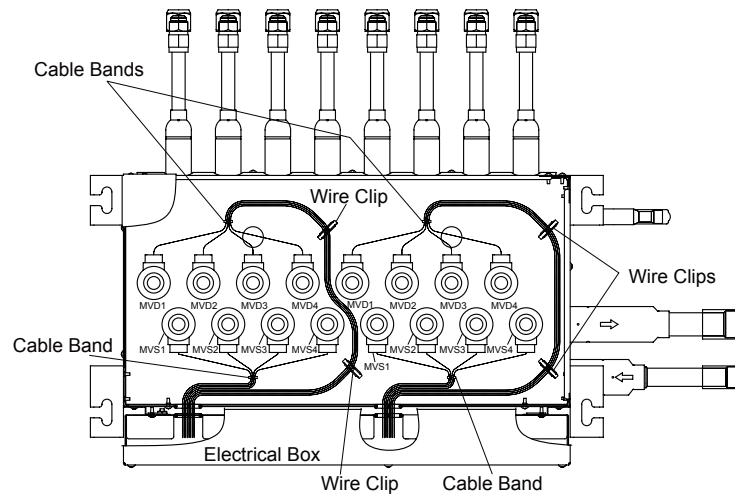

HCHM-N12XA

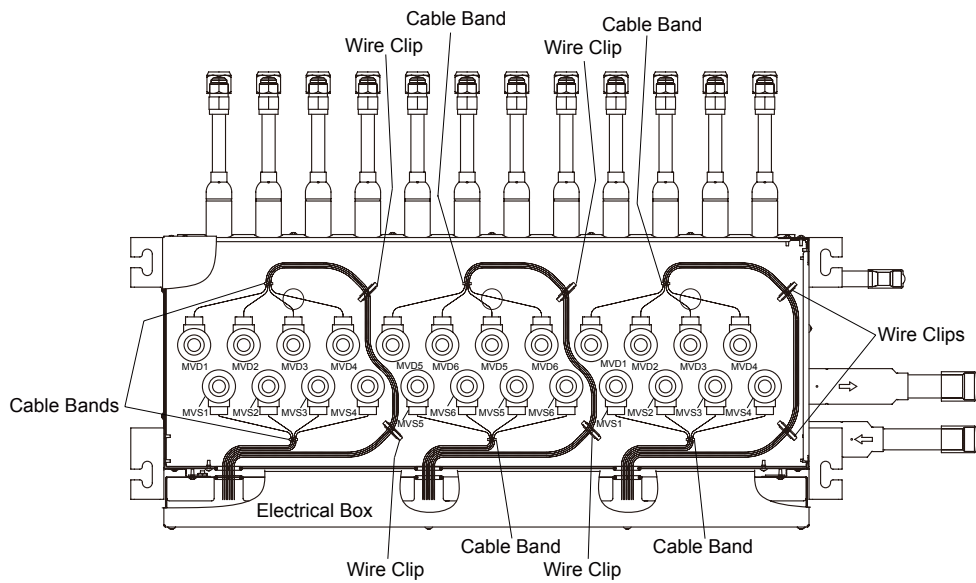

HCHM-N16X

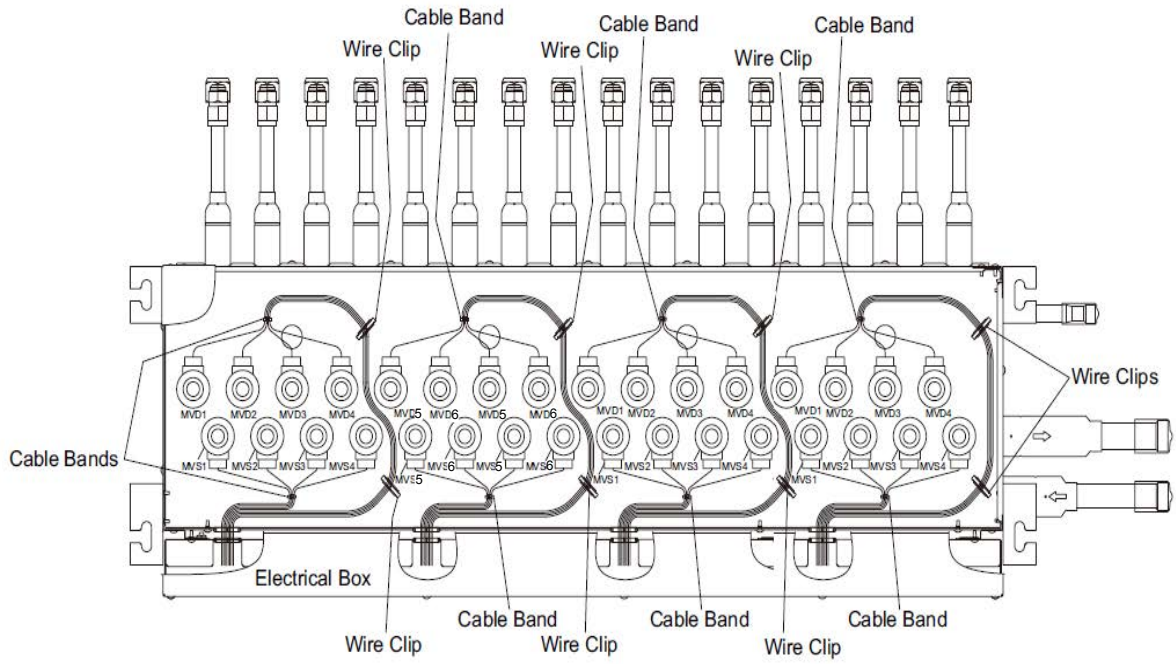

12. Specifications for MVD and MVS

Items	Specifications																																		
Models	PAM-MD12HS-17 - PAM-MD12HS-26																																		
Working temperature range	-30 °C to 70 °C																																		
Refrigerant Used	R410A																																		
Insulation Resistance	Min. 100MΩ (at 500VDC Megohmmeter)																																		
Withstand Voltage	500VAC for 1 minute or 600VAC for 1 second																																		
Rated voltage / operating voltage	DC 12 V ± 1.2 V																																		
Driving current	80mA/phase (at 12VDC 20°C)																																		
Coil resistance (for each phase)	150Ω+10%/phase (at 20oC)																																		
Insulation Class	Class E																																		
Wiring diagram, drive circuit and activation mode	<table border="1" data-bbox="593 913 1321 1126"> <thead> <tr> <th rowspan="2">Connector No.</th> <th rowspan="2">Color of Lead Wire</th> <th colspan="4">Switching mode</th> </tr> <tr> <th>1</th> <th>2</th> <th>3</th> <th>4</th> </tr> </thead> <tbody> <tr> <td>1</td> <td>White (3)</td> <td>ON</td> <td>OFF</td> <td>OFF</td> <td>ON</td> </tr> <tr> <td>2</td> <td>Yellow (4)</td> <td>ON</td> <td>ON</td> <td>OFF</td> <td>OFF</td> </tr> <tr> <td>3</td> <td>Orange (5)</td> <td>OFF</td> <td>ON</td> <td>ON</td> <td>OFF</td> </tr> <tr> <td>4</td> <td>Blue (6)</td> <td>OFF</td> <td>OFF</td> <td>ON</td> <td>ON</td> </tr> </tbody> </table> <p>Movement Method</p> <p>OPEN: 1 - 2 - 3 - 4 - 1 CLOSE: 4 - 3 - 2 - 1 - 4</p> <p>Checking Method</p> <p>Measure the coil resistances between connector No.1 (common) and each phase. The measured resistance value is normal if approximately 150Ω *. (*): Ambient Temperature 20°C</p>	Connector No.	Color of Lead Wire	Switching mode				1	2	3	4	1	White (3)	ON	OFF	OFF	ON	2	Yellow (4)	ON	ON	OFF	OFF	3	Orange (5)	OFF	ON	ON	OFF	4	Blue (6)	OFF	OFF	ON	ON
Connector No.	Color of Lead Wire			Switching mode																															
		1	2	3	4																														
1	White (3)	ON	OFF	OFF	ON																														
2	Yellow (4)	ON	ON	OFF	OFF																														
3	Orange (5)	OFF	ON	ON	OFF																														
4	Blue (6)	OFF	OFF	ON	ON																														
Appearance																																			

13. Safety and Control Device Setting

Switch Box

Model		HCHS-N06XA, HCHS-N10XA, HCHM-N04XA HCHM-N08XA, HCHM-N12XA, HCHM-N16XA
For Control Circuit Fuse	A	3.15

